



**CREATOR<sup>®</sup>**  
CREATOR CORPORATION(CHINA)

**CROSS Series Mixed Matrix Switcher  
User 's Manual**







V1.0 Version

CREATOR CORPORATION CHINA

# The meaning of symbols

## ■ Safety instructions

For your safe and correct use of equipments, we use a lot of symbols on the equipments and in the manuals, demonstrating the risk of body hurt or possible damage to property for the user or others. Indications and their meanings are as follow. Please make sure to correctly understand these instructions before reading the manual.

	<p>This is A level product, which may cause radio interference in the living environment. In this case, users may need to take the feasible measures to get around the interference.</p>
	<p>Remind users that the dangerous voltage without insulation occurring within the equipment may cause people suffer from shock</p>
	<p>CE certification means that the product has reached the directive safety requirements defined by the European Union. Users can be assured about the use of it</p>
	<p>SGS certification means that the product has reached the quality inspection standards proposed by the world's largest SGS.</p>
	<p>This product passed the ISO9001 international quality certification (certification body: TUV Rheinland, Germany).</p>
	<p>Warning: in order to avoid electrical shock, do not open the machine cover, nor is the useless part allowed to be placed in the box. Please contact the qualified service personnel.</p>

## ■ General information instructions

	<p>It lists the factors leading to the unsuccessful operation or set and the relevant information to pay attention to.</p>
---	--

## Important note



### Warning

In order to ensure the reliable performance of the equipment and the safety of the user, please observe the following matters during the process of installation, use and maintenance:

#### **The matters needing attention of installation**

◆ Please do not use this product in the following places: the place of dust, soot and electric conductivity dust, corrosive gas, combustible gas; the place exposed to high temperature, condensation, wind and rain; the occasion of vibration and impact. Electric shock, fire, wrong operation can lead to damage and deterioration to the product, either;

◆ In processing the screw holes and wiring, make sure that metal scraps and wire head will not fall into the shaft of controller, as it could cause a fire, fault, or incorrect operation;

◆ When the installation work is over, it should be assured there is nothing on the ventilated face, including packaging items like dust paper. Otherwise this may cause a fire, fault, incorrect operation for the cooling is not free;

◆ Should avoid wiring and inserting cable plug in charged state, otherwise it is easy to cause the shock, or electrical damage;

◆ The installation and wiring should be strong and reliable, contact undesirable may lead to false action;

◆ For a serious interference in applications, should choose shield cable as the high frequency signal input or output cable, so as to improve the anti-jamming ability of the system.

#### **Attention in the wiring**

◆ Only after cutting down all external power source, can install, wiring operation begin, or it may cause electric shock or equipment damage;

◆ This product grounds by the grounding wires. To avoid electric shocks, grounding wires and the earth must be linked together. Before the connection of input or output terminal, please make sure this product is correctly grounded;

◆ Immediately remove all other things after the wiring installation. Please cover the terminals of the products cover before electrification so as to avoid cause electric shock.

#### **Matters needing attention during operation and maintenance**

◆ Please do not touch terminals in a current state, or it may cause a shock, incorrect operation;

◆ Please do cleaning and terminal tighten work after turning off the power supply. These operations can lead to electric shock in a current state;

◆ Please do the connection or dismantle work of the communication signal cable, the expansion module cable or control unit cable after turning off the power supply, or it may cause damage to the equipment, incorrect operation;

◆ Please do not dismantle the equipment, avoid damaging the internal electrical component;

◆ Should be sure to read the manual, fully confirm the safety, only after that can do program changes, commissioning, start and stop operation.

#### **Matters needing attention in discarding product**

◆ Electrolytic explosion: the burning of electrolytic capacitor on circuit boards may lead to explosion;

◆ Please collect and process according to the classification, do not put into life garbage;

◆ Please process it as industrial waste, or according to the local environmental protection regulations.

# Preface

CROSS series mixed matrix switcher User 's Manual mainly introduces the operation methods of CROSS-MAX0808,CROSS-MAX1616,CROSS-MAX3232,their main performance parameters and common fault solutions.

This manual is only used as user instruction, not for a repair service usage. The functions or related parameters may be changed since the date of issue, please inquire the supplemental information from CREATOR Electronics or local distributors.

The copyright of this manual belongs to CREATOR Electronics. Without permission, no unit or individual shall adopt part or all of its content for commercial use.

The manual is protected by of the Copyright Law of the Peoples Republic of China and other regulations about intellectual property rights. Without written permission shall not be copied or distributed.

# Catalog

Chapter 1 Summary.....	1
1.1 Equipment.....	1
1.2 Features Characteristics.....	1
1.3 Specifications.....	2
1.4 Controller Installation.....	3
1.5 System Connection Diagram.....	4
Chapter 2 Hardware Description.....	5
2.1 CROSS-MAX0808 Panel View.....	5
2.2 CROSS-MAX1616 Panel View.....	6
2.3 CROSS-MAX3232 Panel View.....	7
2.4 Matrix's Connection with Peripherals.....	9
2.4.1 Input Interface Description.....	9
2.4.2 Output Interface Description.....	9
2.4.3 Communication Port and Its Connection Method.....	9
2.4.4 Control Interface of Matrix RS-232.....	9
2.4.5 The Connection between Matrix and Control Computer.....	9
2.4.6 Matrix KEYBOARD Interface.....	9
2.4.7 The Connection between Matrix and Extended Keyboard.....	10
2.4.8 Matrix Network Interface.....	10
2.4.9 The Connection Between Matrix and Computer Signal Input and Output Devices.....	11
2.4.10 DB15 Male Socket Transfer Line (S terminal, RCA head).....	12
2.4.11 PB-900 Power Supply Box.....	12
Chapter 3 Control Panel Operating Instructions.....	14
3.1 Matrix Panel Description.....	14
3.2 Controller Panel Buttons Instructions.....	18
3.2.1 Switching Operation Example.....	18
3.2.2 Save and Call Operation Example.....	19
3.3 "Matrix Net Tool" Software Description.....	19
3.3.1 Software Running Environment.....	19
3.3.2 Software Startup.....	20
3.3.3 Open Program.....	20
3.3.4 The Main Interface.....	20
3.4 Remote Control Description.....	20
3.4.1 Functionality.....	20
3.4.2 System components.....	20
3.4.3 Connection Diagram.....	21
3.4.4 Instructions.....	21
Chapter 4 Input, Output Card Instructions.....	23
4.1 Card Type.....	23
4.2 Input Card.....	23
4.2.1 Xin-HDMI8 Input Card Function Characteristics.....	23
4.2.2 Xin-DVI8 Input Card Function Characteristics.....	23

4.2.3	Xin-CAT8 Input Card Function Characteristics.....	24
4.2.4	Xin-COMP8 Input Card Function Characteristics.....	24
4.2.5	Xin-SF8 Input Card Function Characteristics.....	24
4.3	Output Card.....	24
4.3.1	Xout-HDMI8 Output Card Function Characteristics.....	24
4.3.2	Xout-DVI8 Output Card Function Characteristics.....	24
4.3.3	Xout-CAT8 Output Card Function Characteristics.....	24
4.3.4	Xout-SF8 Output Card Function Characteristics.....	24
4.4	Optional Accessories.....	24
4.4.1	FAN ASSEMBLY Function Characteristics.....	24
4.4.2	BC-100 Blank Card Function Characteristics.....	24
4.4.3	PB-900 Power Supply Box Function Characteristics.....	25
4.5	Specifications.....	25
Chapter 5	Instruction sets.....	31

## Chapter 1 Summary

CROSS series mixed matrix switcher is a matrix signal switcher with flexible configuration. With high-performance hardware design, it perfectly supports a variety of high-definition digital / analog signal switching process, and supports bi-directional RS-232, bidirectional IR signal distribution switching function. By providing one-stop solution to all sectors of video and control signal distribution switch processing, it can be widely used in radio and TV broadcasts, multimedia conference room, large screen display engineering, television education, command and control centers and other places.

CROSS series mixed matrix switcher provides local direct input of HDMI, DVI, VGA, CVBS, S-Video, YPbPr signals, as well as HDMI, DVI signals' direct output. In addition, it provides the twisted pair (HDBaseT) input-output card, which with the twisted pair can prolong the transmission distance of input and output signals of the CAT5e/6 twisted-pair cable to 100M. And it provides fiber input-output card, which with the optical transmitter can extend the input and output distance to 300M by a single core signal transmission multimode fiber. Digital signal processing technology can ensure the signal without distortion, the best quality image is sent to the display terminal.

By custom configuration, the same or different types of input /output cards can be consist of a single interface type or multi-interface type matrix, such as fiber matrix, HDMI matrix, DVI matrix, CAT5 matrix, VGA matrix, YUV matrix, S-Video matrix, Video matrix and so on.

CROSS series mixed matrix switcher has a variety of control modes, supports crystal keys panel operation and RS-485 extended keyboard operation. It provides two standard RS-232 communication interfaces and network ports as well to facilitate the user's conjunction operation

with a variety of remote control devices (such as Crestron ,AMX, CREATOR, etc.).

### 1.1 Equipment

CROSS-MAX0808

CROSS-MAX1616

CROSS-MAX3232

The mixing matrix can be composed of any of the following output cards.

Input card:

Xin-HDMI8 input card (HDMI input)

Xin-DVI8 input card (DVI input)

Xin-CAT8 input card (HDBaseT signal input)

Xin-COMP8 input card (support for CV, SV, YPbPr, VGA signal input)

Xin-SF8 input card (FIBER signal input)

Output card:

Xout-HDMI8 output card (HDMI output)

Xout-DVI8 output card (DVI output)

Xout-CAT8 output card (HDBaseT signal output)

Xout-SF8 output card (FIBER signal output)

Optional accessories:

FAN ASSEMBLY card (auxiliary fan card)

BC-100 blank card (shield)

PB-900 power supply box (redundant power supply box)

Cooling card (inhale air)

### 1.2 Features Characteristics

- ◆ Full digital switching;
- ◆ Support switching function of any positive fast channel signal and embedded control signal
- ◆ Support positive fast channel and the embedded control signal separation switching mode;
- ◆ Supports bidirectional RS-232 and bidirectional IR signal switching function of HD embedded signal;

- ◆ The positive fast channel signal support fast channel support DVI 1.0 protocol, 3D protocol of HDMI 1.4, HDCP 1.3 protocol;
- ◆ Flexible control mode, key panel operation, RS-485 extended keyboard operation, also offers 2 standard RS-232 communication interface and network port, convenient for users to work with a variety of remote control equipment;
- ◆ Plug-in card design, flexible for configuration with different input and output signal type and signal channel number.

## 1.3 Specifications

### Parameters

Equipment Model		8 series	16 series	32 series
Chassis height		3U	5U	10U
Effective number of slots	Input slot	1	2	4
	Output slot	1	2	4
Input (maximum signal road number)	Xin-HDMI8	8	16	32
	Xin-DVI8	8	16	32
	Xin-CAT8	8	16	32
	Xin-COMP8	8	16	32
	Xin-SF8	8	16	32
Output (maximum signal road number)	Xout-HDMI8	8	16	32
	Xout-DVI8	8	16	32
	Xout-CAT8	8	16	32
	Xout-SF8	8	16	32
Fan assembly card	FAN ASSEMBLY	1	1	2



## 1.4 Controller Installation

The matrix controller uses all metal box ,it can be mounted on a standard 19inch cabinet, steps are as follows:

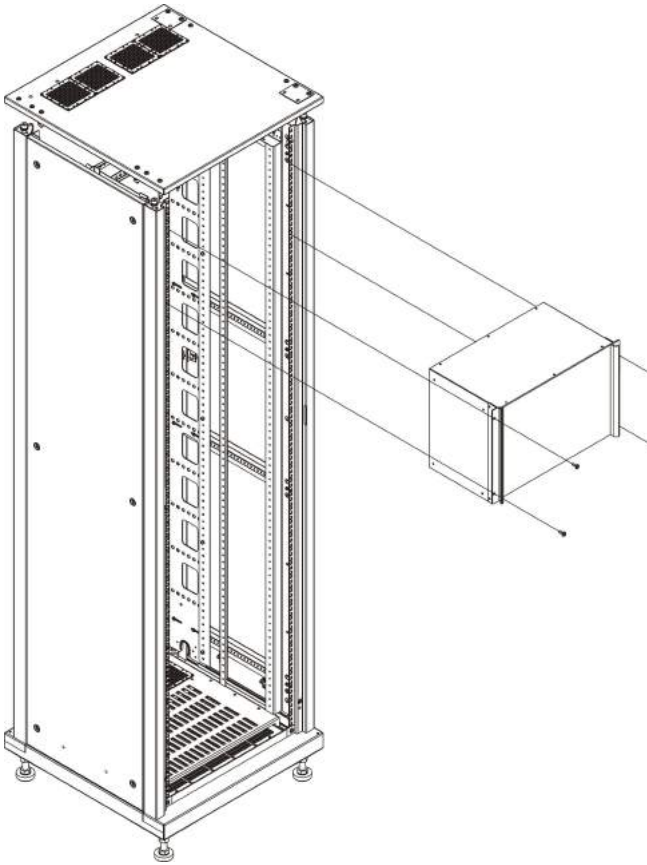

### 1.5 System Connection Diagram

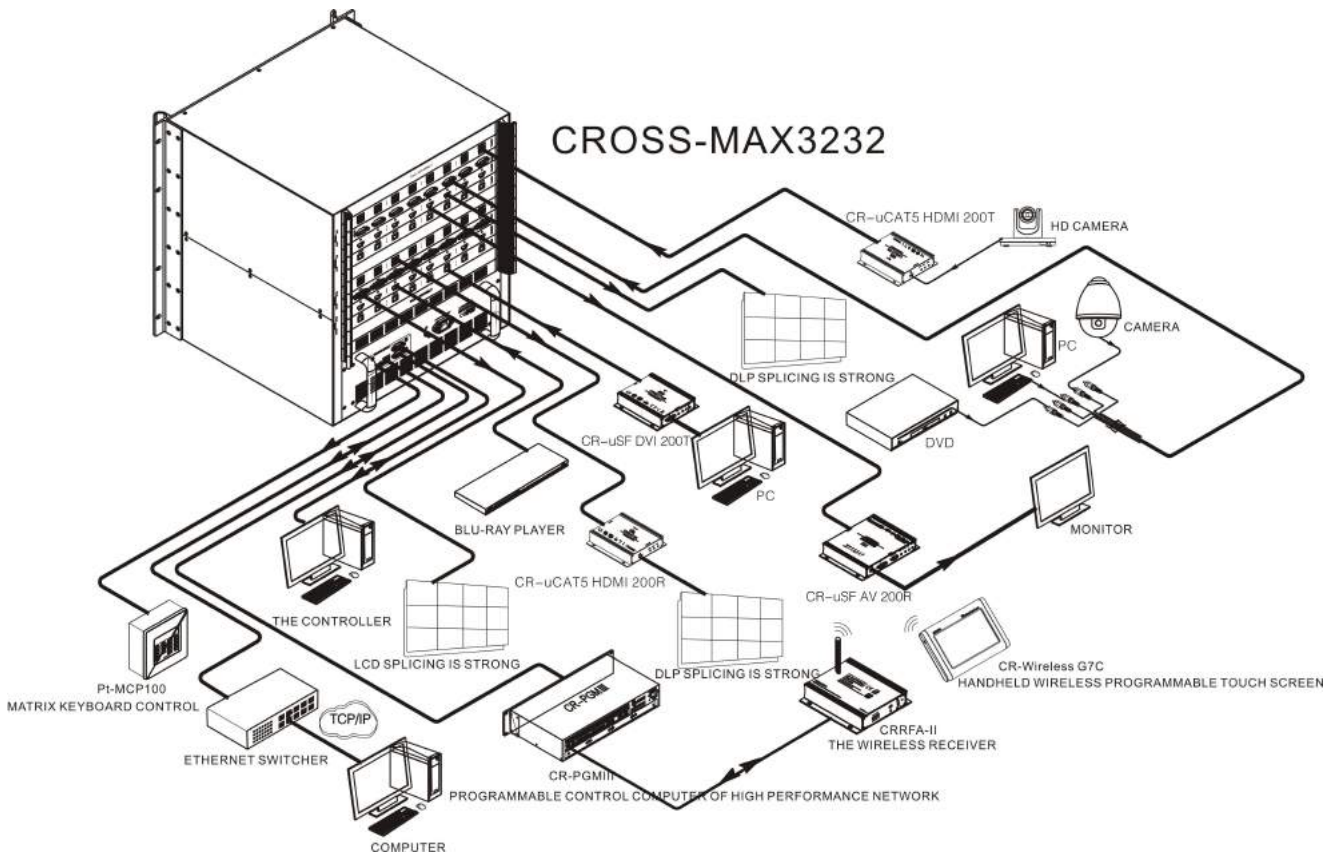

## Chapter 2 Hardware Description

### 2.1 CROSS-MAX0808 Panel View

front panel:

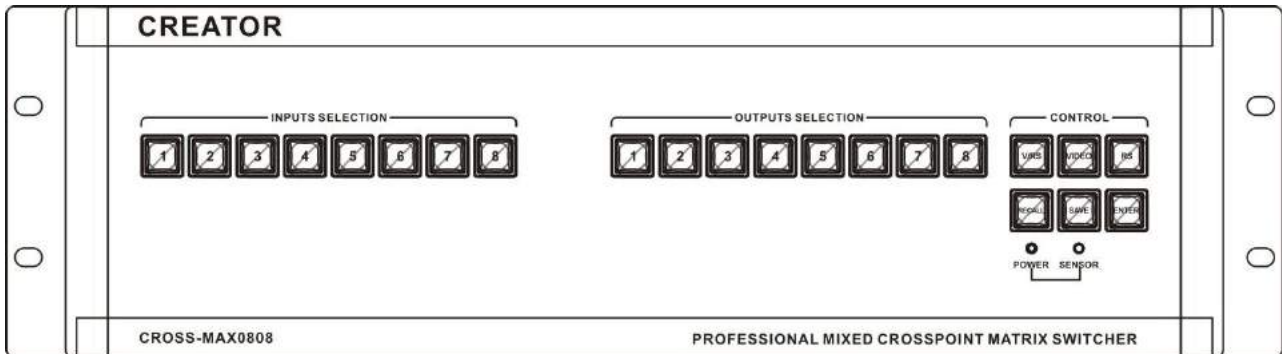

rear panel:

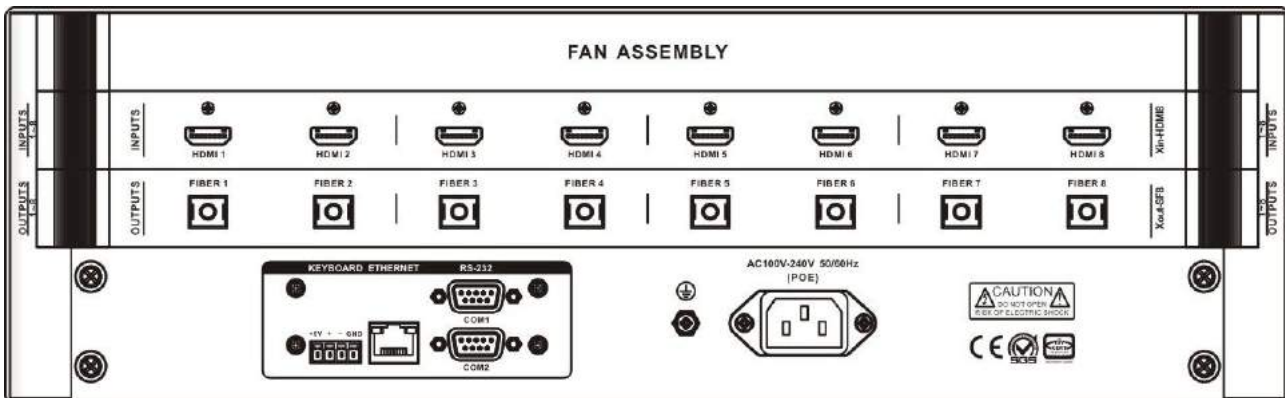

## 2.2 CROSS-MAX1616 Panel View

front panel:

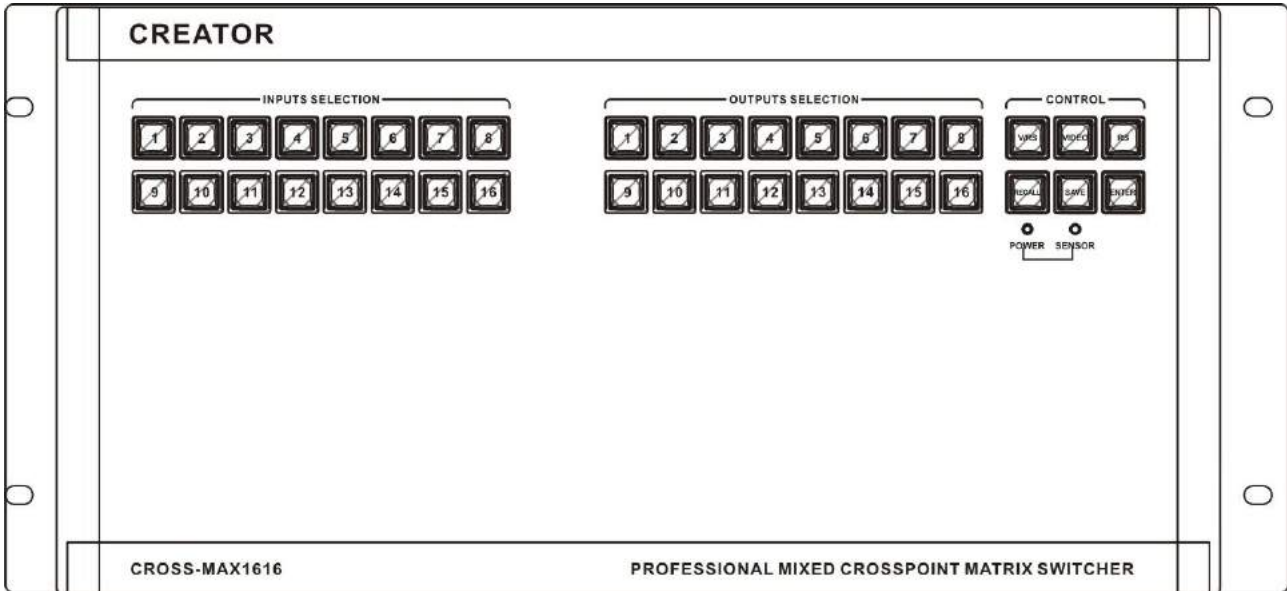

rear panel:

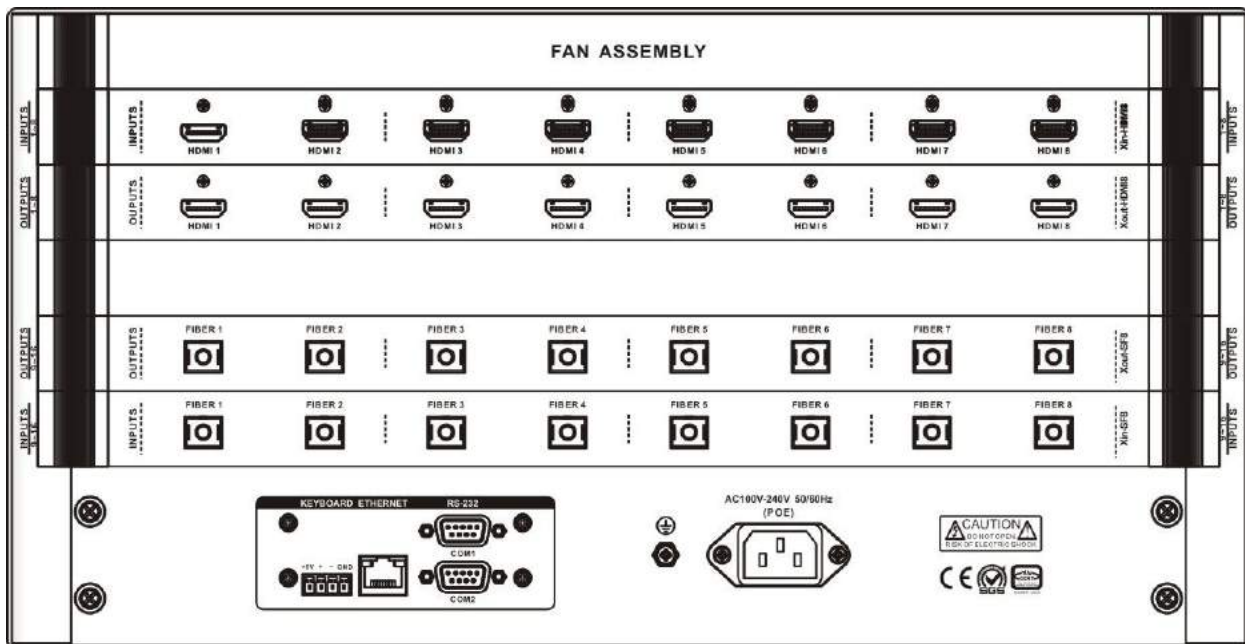

### 2.3 CROSS-MAX3232 Panel View

front panel:

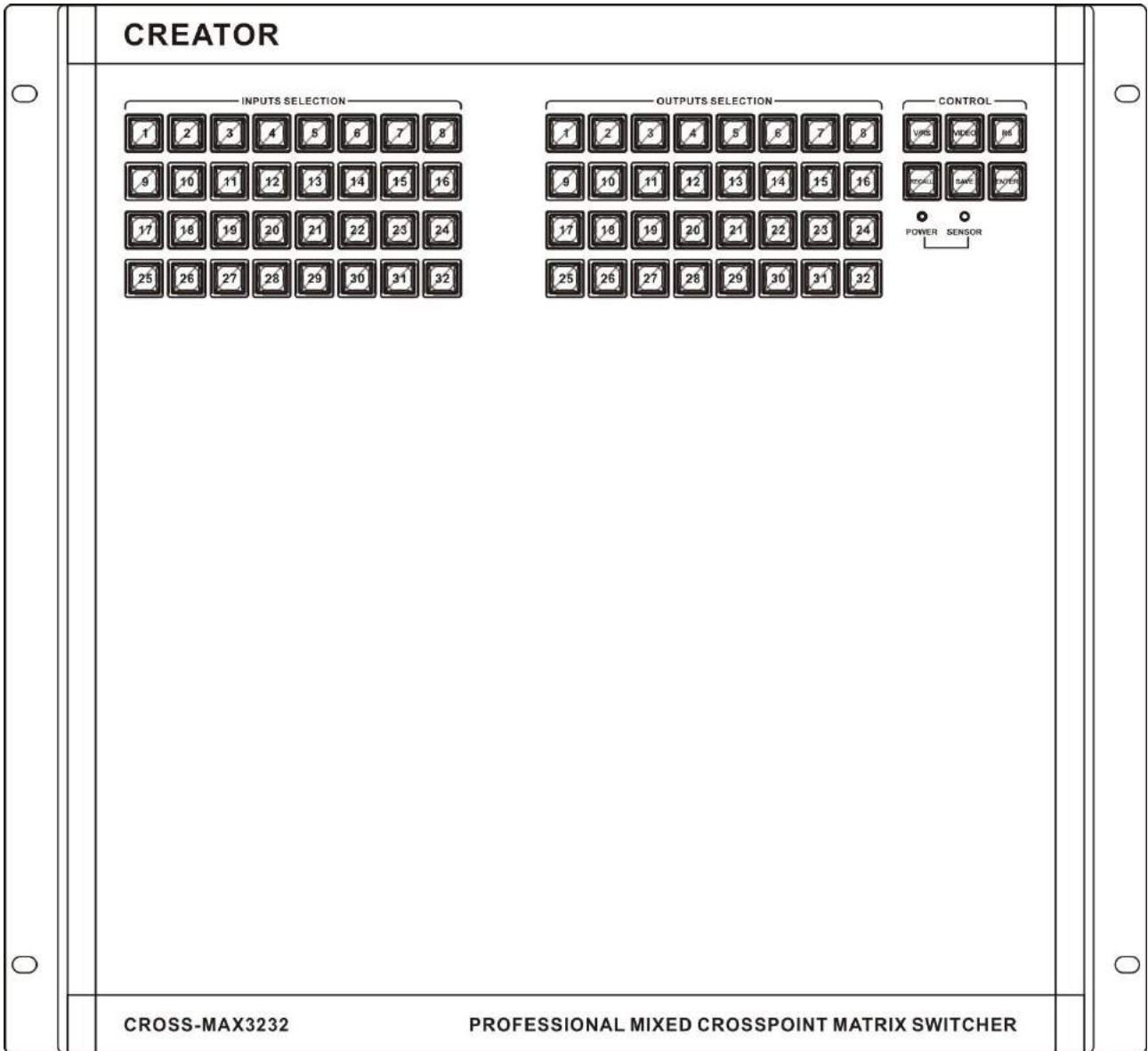

rear panel:

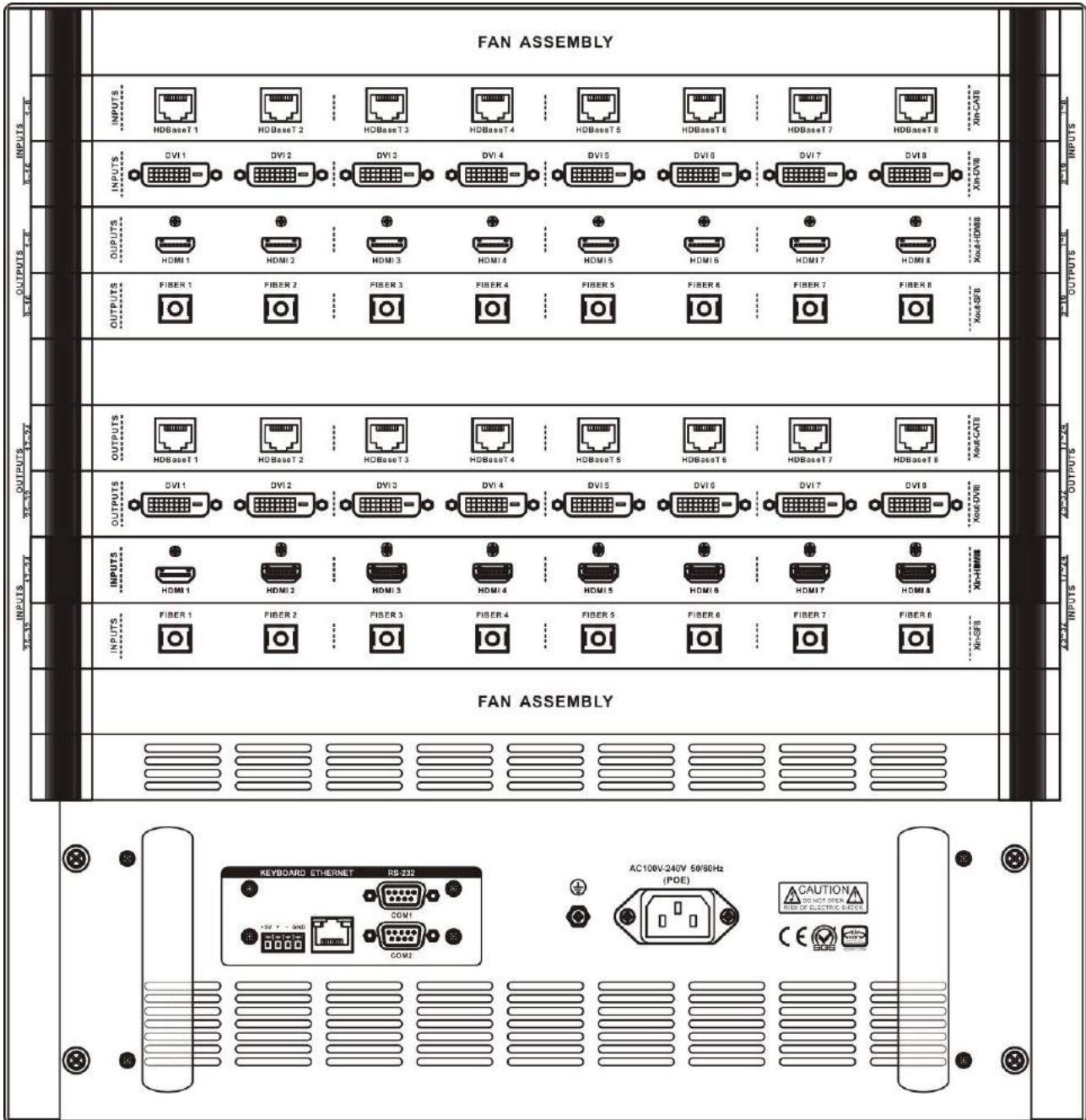

## 2.4 Matrix's Connection with Peripherals

### 2.4.1 Input Interface Description

Xin-DVI8, Xin-HDMI8, Xin-CAT8, Xin-COMP8, Xin-SF8 input card can be combined into any input signal type.

### 2.4.2 Output Interface Description

Xout-DVI8, Xout-HDMI8, Xout-CAT8, Xout-SF8 output cards can be combined into any output signal type.

### 2.4.3 Communication Port and Its Connection Method

Digital seamless switching matrix provides standard RS-232 serial communication ports. Addition to switch operation by the front panel keys, it also can be used in various control systems (such as personal computers, CREATOR control systems, control systems from other manufacturers) to control.

### 2.4.4 Control Interface of Matrix RS-232

Digital seamless switching matrix provides 2-way RS-232 serial interface, you can control the matrix through the interface. The RS-232 port is a DB9 female connector. Pins as follows::

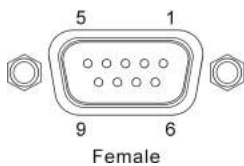

Pin	Signal	Description
1	-	-
2	TXD	Used for RS-232 protocol,send data
3	RXD	Used for RS-232 protocol,receive data
4	-	-

5	GND	Signal ground
6	-	-
7	-	-
8	-	-
9	-	-

### 2.4.5 The Connection between Matrix and Control Computer

Connecting the computer's serial communication port (COM1 or COM2) with the matrix controller RS-232 communication port by RS-232 cable, user can control the matrix with corresponding instructions. Refer to the "Chapter 5 instruction sets" for details.

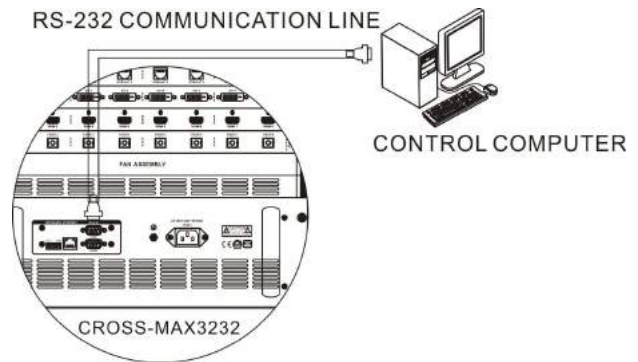

### 2.4.6 Matrix KEYBOARD Interface

Matrix provides 1-way KEYBOARD interface, through which you can connect to extended keyboard MCP100, and do channel switching operation of the matrix. KEYBOARD has 4 3.8mm Phoenix interface pins as follows:

**+5V + - GND**

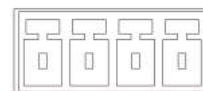

Pin	Signal	Description
1	+5V	Put out DC5V/1A,provide working power for MCP100
2	+	Used in RS-485Protocol,DATA+
3	-	Used in RS-485Protocol,DATA-
4	GND	Signal ground

### 2.4.7 The Connection between Matrix and Extended Keyboard

Connect the matrix controller KEYBOARD interfaces with matrix interfaces of extended keyboard MCP100 one by one according to silk screen with line, you can control the matrix. Details can be found in CR-MCP100 matrix keyboard user's manual.

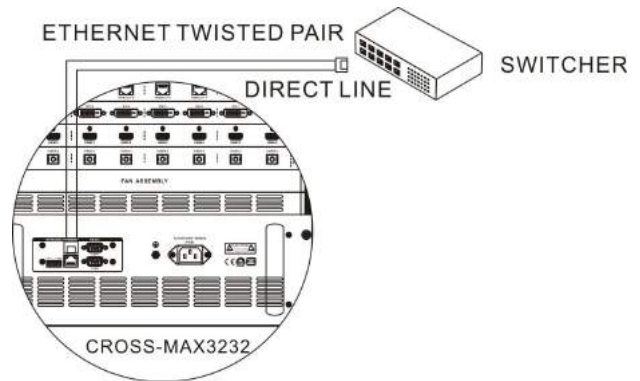
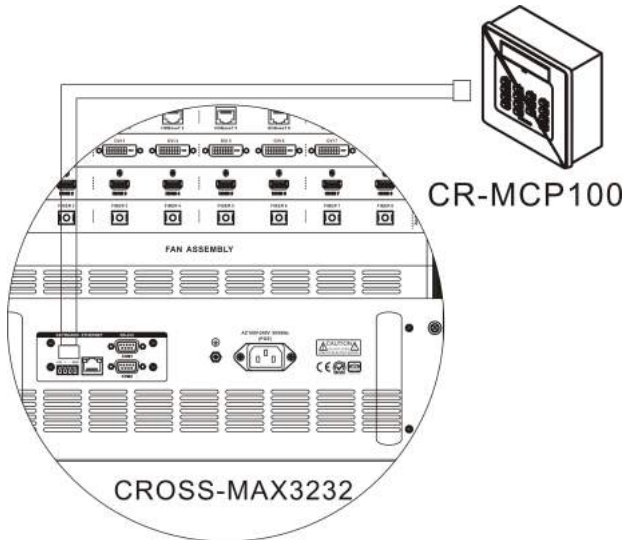

### 2.4.8.2 Connection Description of RJ45 Network Port Direct Line and Cross-line:

The system adopts the CAT-5 (super 5 cable) as the wire. Install RJ45 connector (commonly known as crystal head) at both ends of the CAT-5 to connect network devices. The standard connection of twisted pair cable is not predetermined. The purpose is to ensure the symmetry of the layout of cable splice, so you can make the interference between the joint inner cables cancel each other. General UTP line has four pairs of twisted thin line, and marked with different colors.

Twisted pair line has two configurations: EIA / TIA 568B standard and EIA / TIA 568A standard.

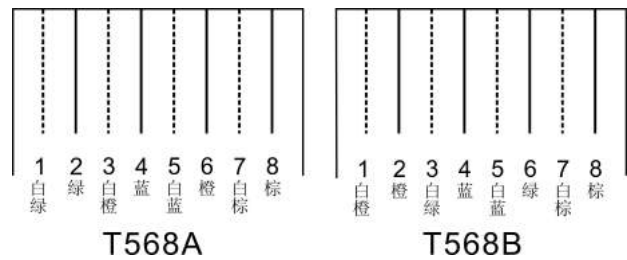

### 2.4.8 Matrix Network Interface

#### 2.4.8.1 Hardware Connection

Matrix connects to Ethernet adapter hardware in two ways:

1) Cross-connection

Matrix directly connects to control computers via CAT-5 crossover cable.

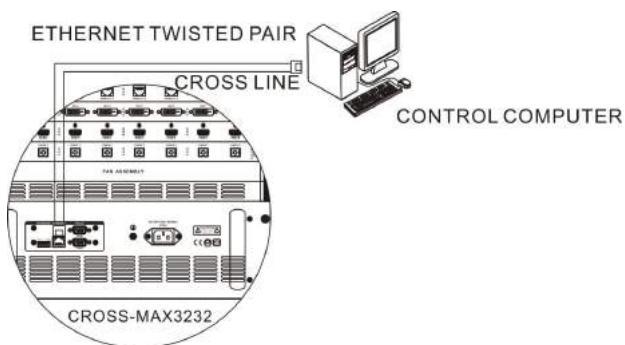

2) Direct connection method

Matrix connects to an Ethernet switcher or hub via CAT-5 straight-through cable.

T568A linear order							
1	2	3	4	5	6	7	8
whi te gre en	gre en	Wh ite ora nge	blu e	Wh ite blu e	ora nge	Wh ite bro wn	bro wn



T568B linear order							
1	2	3	4	5	6	7	8
White	Orange	White	Blue	White	Green	White	Brown
Orange		Green	Blue	Blue	Green	Brown	

Direct line: two ends connected according to T568B wire order standard.

Cross-line: One end connected according to T568A line order, the other connected according to T568B linear order standard.

### 2.4.9 The Connection Between Matrix and Computer Signal Input and Output Devices

It connects various computer signal, audio and video signal device according to different occasions. Such as disc machine, desktop computer, workstation, digital display table, etc.. Output terminal can be connected to the projector, recorder, computer monitors, power amplifier etc..

#### 2.4.9.1 HDMI-A Type Link

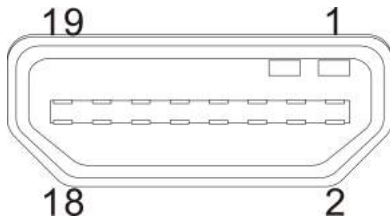

HDMI-A pinout table

PIN	Description
1	TMDS Data2+
2	TMDS Data2 Shield
3	TMDS Data2-
4	TMDS Data1+
5	TMDS Data1 Shield
6	TMDS Data1-
7	TMDS Data0+
8	TMDS Data0 Shield
9	TMDS Data0-

10	TMDS Clock+
11	TMDS Clock Shield
12	TMDS Clock-
13	CEC
14	Reserved (in cable but N.C. on device)
15	SCL
16	SDA
17	DDC/CEC Ground
18	+5V Power
19	Hot Plug Detect

#### 2.4.9.2 DVI Port Description

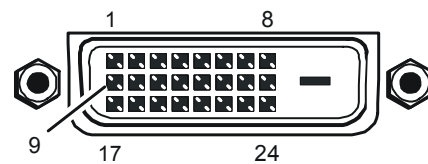

PIN	Description
1	T.M.D.S.Data2-
2	T.M.D.S.Data2+
3	T.M.D.S. Data 2/4 Shield
4	T.M.D.S. Data 4-
5	T.M.D.S. Data 4+
6	DDC Clock
7	DDC Data
8	No Connect
9	T.M.D.S.Data1-
10	T.M.D.S.Data1+
11	T.M.D.S.Data1/3 Shield
12	T.M.D.S.Data3-
13	T.M.D.S.Data3+
14	+5V Power
15	Ground (for +5V)
16	Hot Plug Detect
17	T.M.D.S. Data 0-
18	T.M.D.S. Data 0+
19	T.M.D.S. Data 0/5 Shield
20	T.M.D.S.Data5-
21	T.M.D.S.Data5+
22	T.M.D.S. Clock Shield
23	T.M.D. S. Clock +
24	T.M.D.S .Clock-

### 2.4.10 DB15 Male Socket Transfer Line (S terminal, RCA head)



#### 2.4.10.1 DB15 Male Socket Transfer Line Definitions

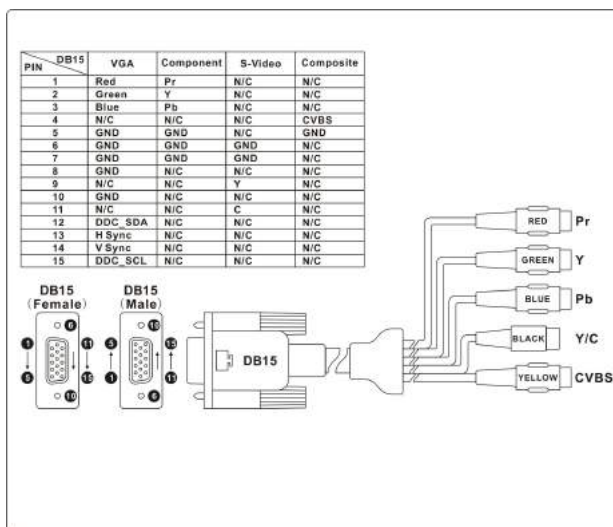

### 2.4.11 PB-900 Power Supply Box

**Note:**Optional accessory power supply box PB-900 is used for CROSS-MAX3232 redundant power cold backup, and supports quick change on scene. The power supply box can provide +5VDC (420W) +12VDC (480W), a total of 900W rated power. The power supply box adopts the international first-class brand high-quality switching power supply, ensuring that no problem will appear in five years. And once failure occurs, it can be replaced fast and conveniently.

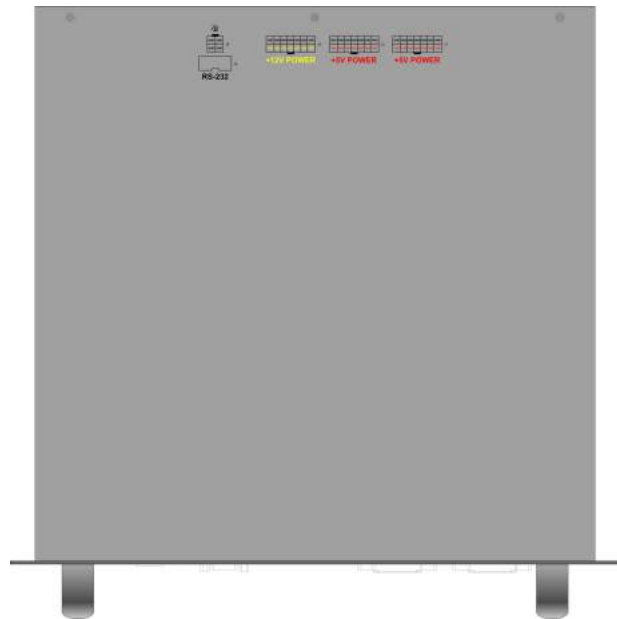

Methods to replace the power supply box:

1. Open the screws at the left and right side of power supply box, hold the corresponding handles, pull it out slowly.
2. Press the hook besides the wire, pull off the connector inserted in the power supply box back one by one, put on the new power supply box, reconnect the related interface printing line in accordance with the note on the power supply box. Special attention should be paid to the position and color matching of the corresponding lines. There are 5 connecting lines. Including a grounding interface connecting line (4PIN white power socket corresponds with yellow green line), a control interface connecting line (10PIN flat gray line), a +12V POE power connecting line (14PIN white power socket corresponds with yellow and black line), two +5V main power connection lines (14PIN white power socket corresponds with red and black lines). Schematic diagram as follows:

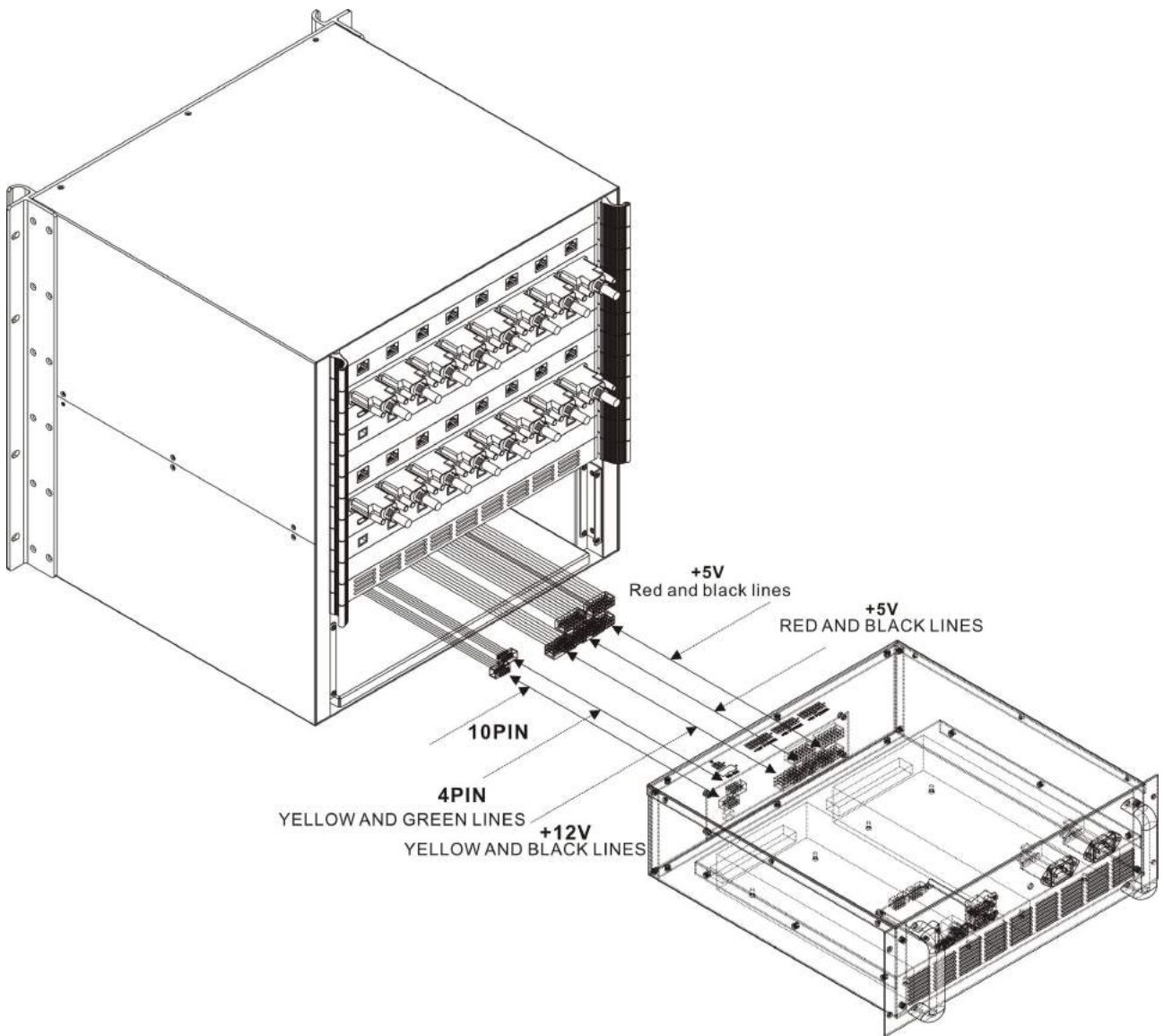

# Chapter 3 Control Panel Operating Instructions

## 3.1 Matrix Panel Description

CROSS-MAX0808 front panel:

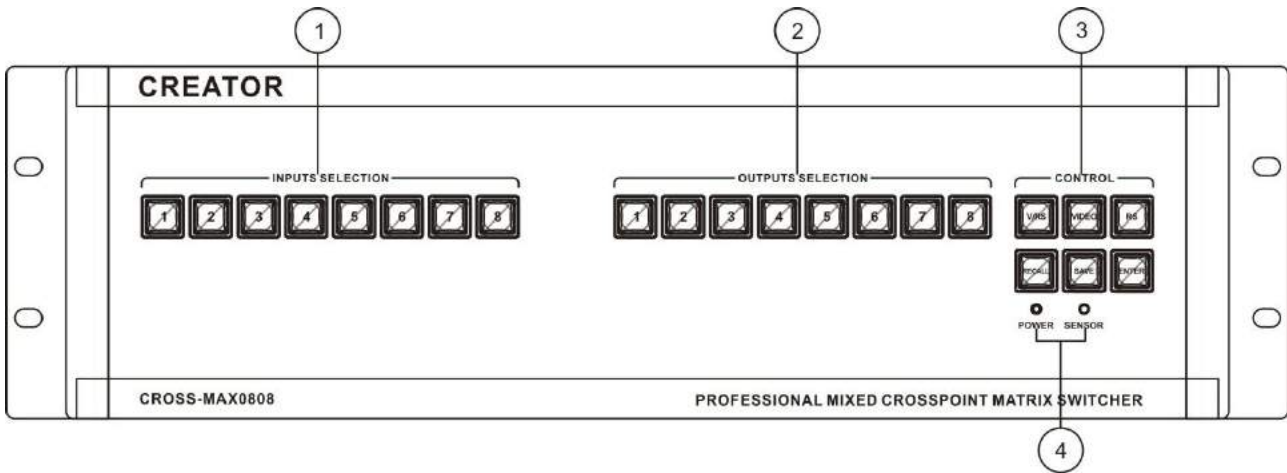

CROSS-MAX0808 rear panel:

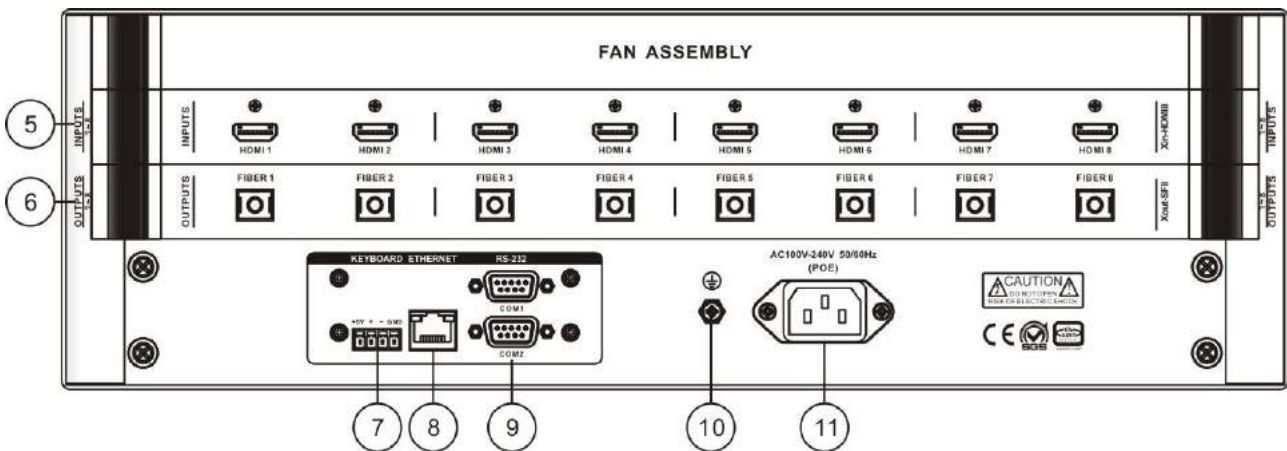

CROSS-MAX1616 front panel:

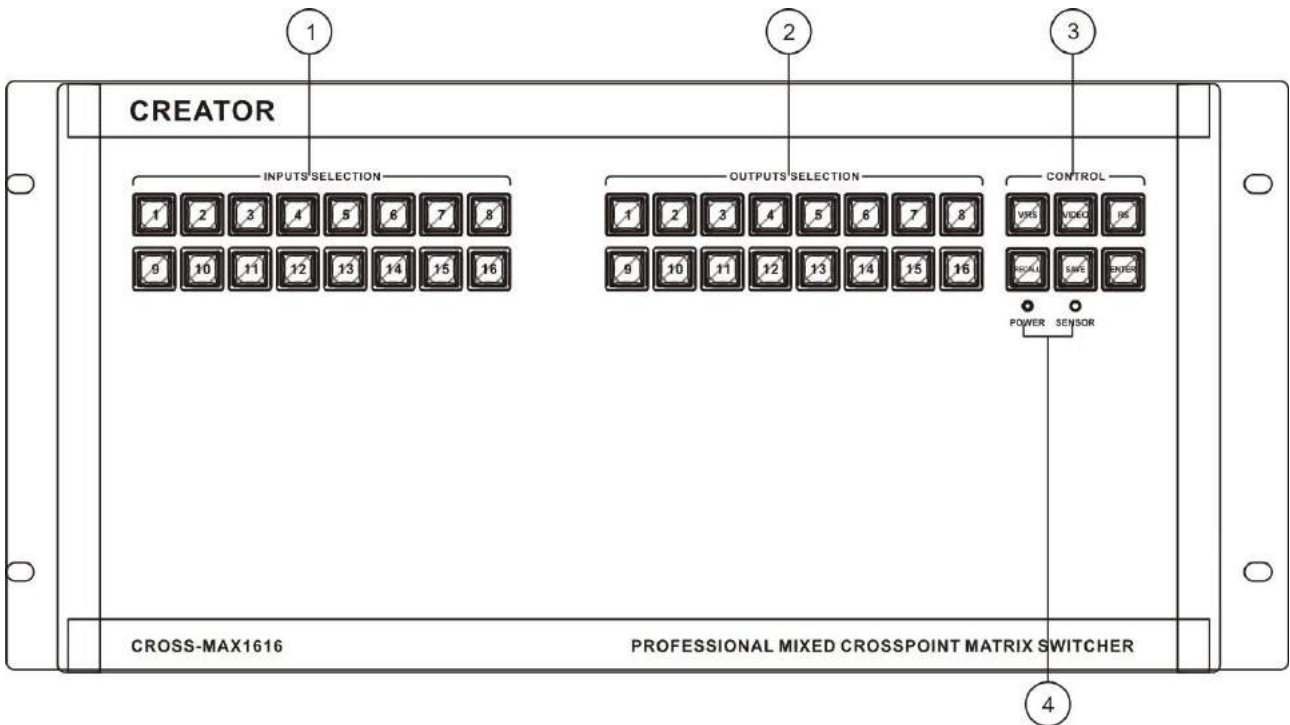

CROSS-MAX1616 rear panel:

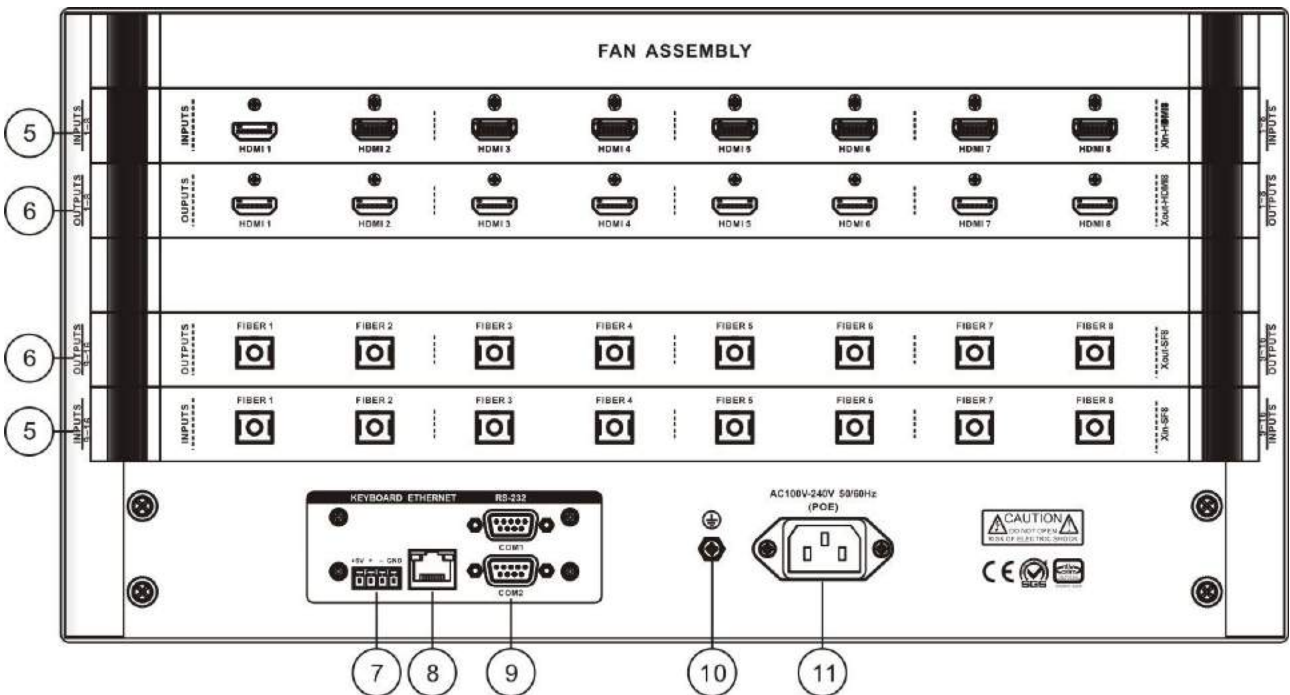

CROSS-MAX3232 front panel:

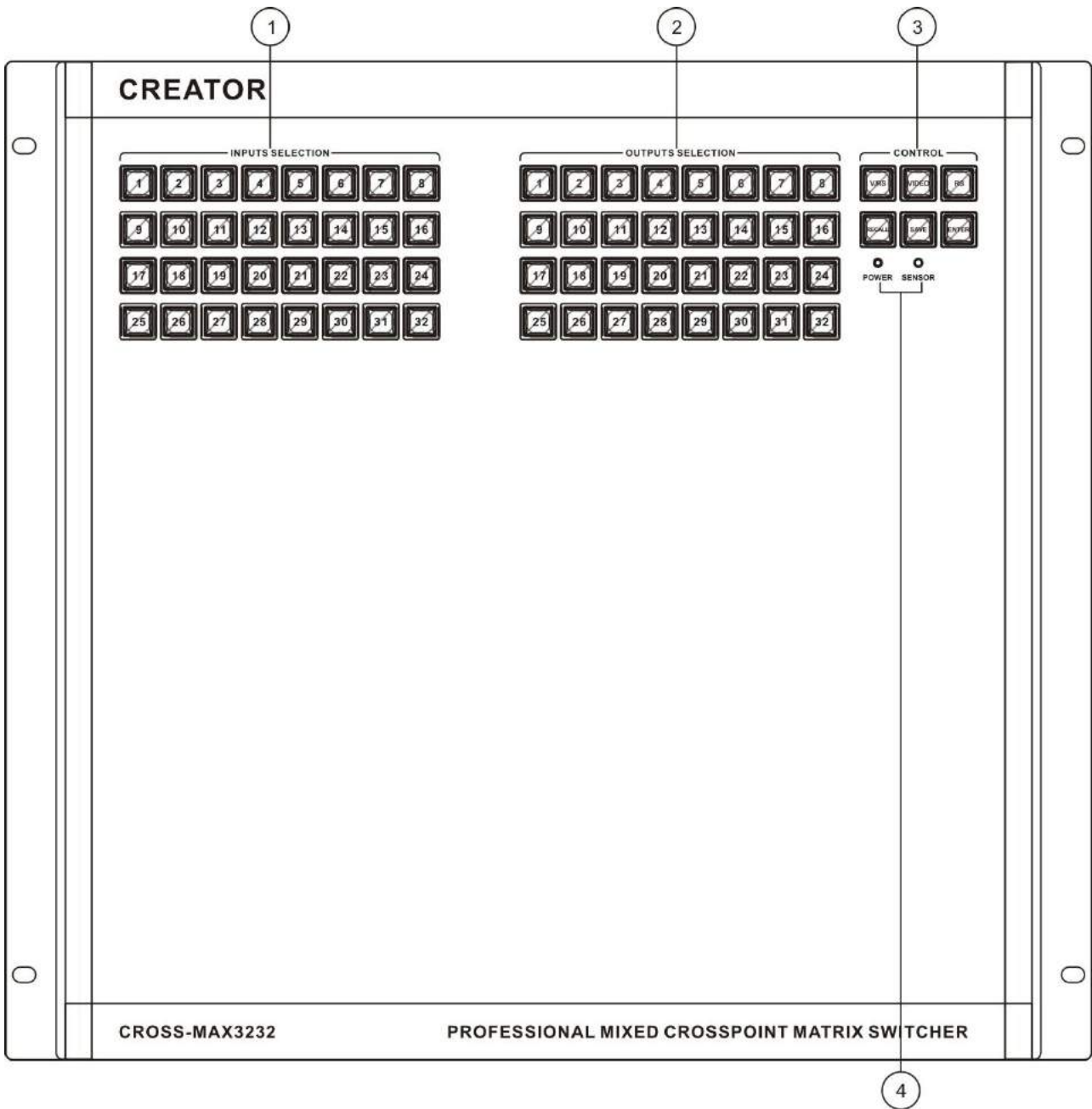

CROSS-MAX3232 rear panel:

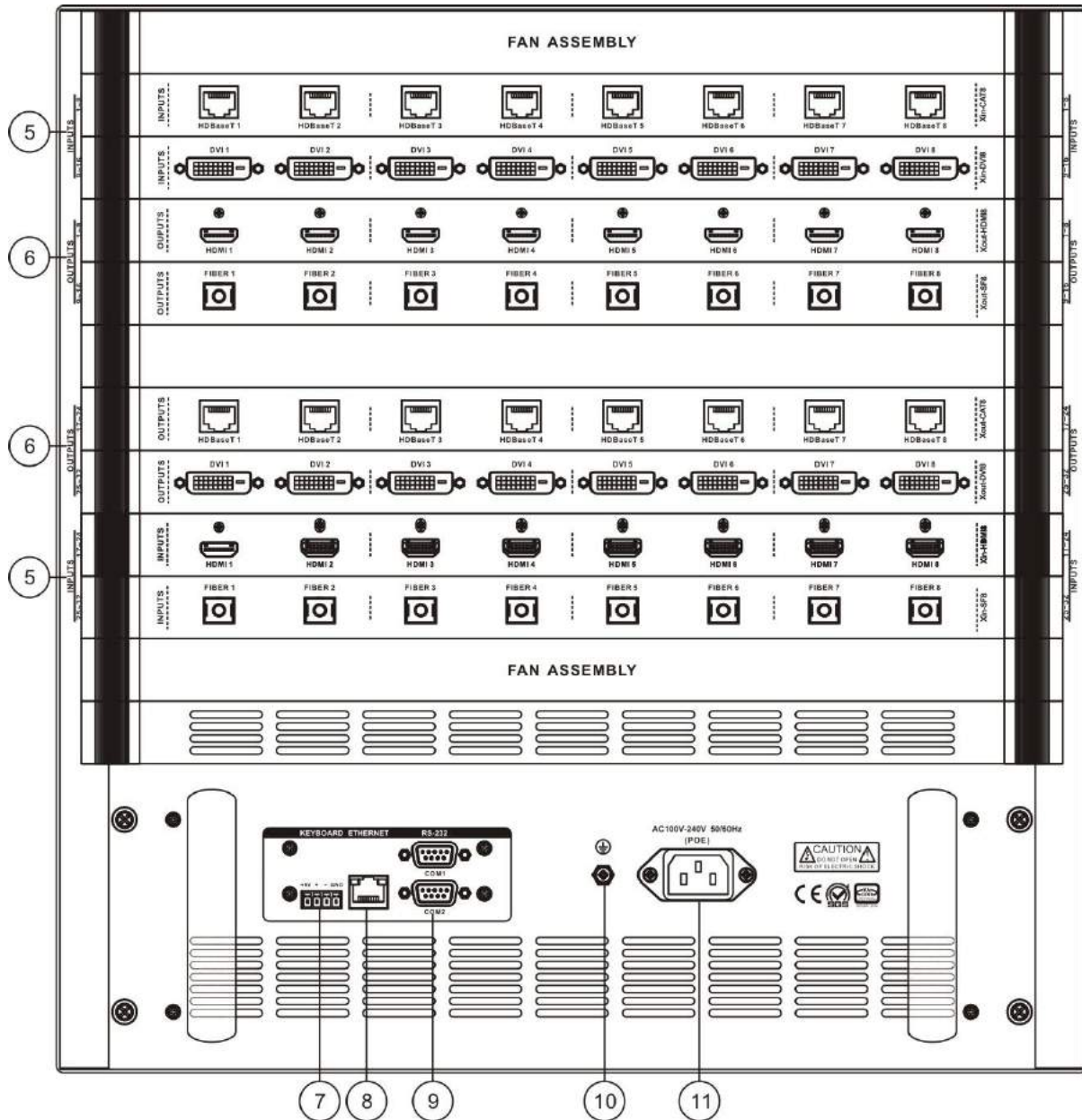

① **INPUTS SELECTION**—Input channel selection key

Signal input channel selection key is used to select input channel of mixed-signals of audio and video, infrared and serial, corresponding to 8/16/32 input ports on rear panel.

② **OUTPUTS SELECTION**—Output channel selection key

Signal output channel selection key is used to select output channel of mixed-signals of audio and video, infrared, and serial, corresponding to

8/16/32 output ports on rear panel.

③ **CONTROL**—Signal control area

**V/RS:**For audio and video signals switcher with forward RS-232 and IR control signals

**VIDEO:**For separate switch of audio and video signals

**RS:** Separate switch of forward RS-232 and IR control signals

**RECALL:**Used in CROSS-MAX0808/1616/3232 controller to call the switching status of the preset group.

**SAVE:**Used in CROSS-MAX0808/1616/3232 controller to save the current switching state to specified default group.

**ENTER:**Short Press to confirm the switching selection , perform switching action.



1.RS-232 and IR panel operation are forward (forward: input connect RS-232 or IR sender, output connect RS-232 or IR receiver);

2.RS-232 and IR reverse switch to toggle through the machine's serial instruction (reverse: input connected to RS-232 or IR receiver, output connected to the RS-232 or infrared sender) please View serial instructions for serial switcher instruction.

3. Whether forward or reverse switch of infrared and serial signal, one way can be switched to another or more ways, multiple ways cannot be switched at the same time to one way.

④ **POWER:**Power indicator

**SENSOR:**Infrared receiver window

⑤ **INPUTS**—signal input port

Using a variety of card as the input source signal, provide the 8/16/32/ input port, the input source device for connecting the corresponding

⑥ **OUTPUTS**—signal output port

Using a variety of card as the output source signal, provide the 8/16/32/ output port, the output source device for connecting the corresponding

⑦ **KEYBOARD**—extended keyboard interface

One KEYBOARD interface to work with MCP100 keyboard

⑧ **ETHERNET**—RJ45 network interface

Ethernet ports can be used to connect local area networks and the Internet, the green light indicates the connection is normal, orange lights' flashing suggests receiving or transmitting data.

⑨ **RS-232**—RS-232 serial port

2 independent RS-232 ports can be used to connect PC or control equipment to realize the central control of system

⑩ Ground column.

⑪ Power input port

The system supports AC100 ~ 240V 50/60Hz input

## 3.2 Controller Panel Buttons

### Instructions

Use the front panel buttons to quickly switch the signals of the matrix (detailed description of the functions of each button, please refer to the "front panel keys function instruction"), and its operation method is as follows:

Switching mode "+" input channels "+" output channel "+" command confirmation key" ENTER "

Among them:

Switching mode

Audio and video, infrared, serial signals are synchronously or separately switched by V / RS "," VIDEO "," RS "buttons. V / RS key is used when audio and video signal switch together with RS-232 and IR control signal. VIDEO key is for audio and video separate switcher. The RS key is for RS-232 and IR control signals' separate switcher.

Input channels

The current connected channel of signal source to be switched. For instance, the "1 ~ 8" keys on the Pt-CAT0808 panel, represents 1 to 8 channels respectively. Other models are similar to this, please refer to the schematic diagram of the front panel of the corresponding models.

Output channels

The channel external display device connected to. For instance, the "1 ~ 8" keys on the Pt-CAT0808 panel, represents 1 to 8 channels respectively. Other models are similar to this, please refer to the schematic diagram of the front panel of the corresponding models.

#### 3.2.1 Switching Operation Example

Example: synchronously switch the first channel audio and video, and RS-232 and IR control



signals to the output channels of no.3, no.4 channel

The steps are as follows:

1, Press switching mode "V / RS" button, lamp is lit.



2. Press input channel "1" key, the key lamp is lit.



3 Press output channels "3,4" keys, the key lamps are lit. Key light "ENTER" has been in a flashing state, suggest whether to confirm the operation.



4.Press the command key "ENTER" to perform operations, all the lit key lamps are closed. At the same time, output device will display corresponding information to indicate that operation was successful.



The operation methods of button "VIDEO" and "RS" are as described above, no longer elaborate here.

### 3.2.2 Save and Call Operation Example

Example: synchronously input the audio and video, and RS-232 and IR control signal of the current 1st channel, the 3rd and 4th output channels are saved as No. 6, and call.

The steps are as follows:

1.Press the "SAVE" button, the button lamp is lit.



2.Press input channels key "6" , key lamp is lit, indicating the operation is successful, the current input, the output state is saved to the 6th storage unit



3.Press the "RECALL" button, the button lamp is lit.



4.Press the input channel key "6", key lamp is lit, call up the input and output state of the 6th storage unit.



## 3.3 “Matrix Net Tool” Software

### Description

"Matrix Net Tool" matrix control software is used with CAT-5 digital matrix switcher to set the network parameters of the matrix.

#### 3.3.1 Software Running Environment

Window98/2000/NT/XP/Vista/Win7 operating system

32M or more memory

10M or more hard disk space

CD-ROM

At least one serial communication port

### 3.3.2 Software Startup

Turn off the matrix and computer power. The matrix RS-232 interface and the computer's RS-232 communication port are connected with a randomly distributed communication line;  
Power on matrix and computer; run the Matrix Net Tool Setup.exe of randomly distributed CD-ROM on the control computer, after installation, you can enter the control software interface.

### 3.3.3 Open Program

The "Start" on the left bottom of windows → Programs → Matrix Net Tool → the Matrix Net Tool to enter the main program screen.

### 3.3.4 The Main Interface

The main interface of "Matrix Net Tool" is shown in Figure 2-1.

Right-click an empty space in the main interface, then pop-up

"Set Com Port" window, shown in Figure 2-2, you can choose different computers COM ports to communicate with matrix.

Can set network port, IP address, subnet mask, gateway and MAC address of matrix through the main interface.

"Current Settings" reads the current network port parameters of the matrix; "Default Settings" to restore the matrix network port parameters to the factory defaults. The factory default value is as follows:

Port number: 5000

IP address: 192.168.0.2

Subnet Mask: 255.255.255.0

Gateway: 192.168.0.1

Hardware address: 0x00: 0x11: 0x22: 0x33: 0x44: 0x55



Figure 2-1



Figure 2-2

## 3.4 Remote Control Description

### 3.4.1 Functionality

Realize remote control in the Ethernet environment, namely, remote client control local matrix device via the Internet.



Local matrix devices and remote clients in the following description will be respectively represented by server and client.

### 3.4.2 System components

1. Controlled device (matrix controller)
2. Network switcher or router
3. Internet accessible PC
4. Straight-through cable



These system components merely refer to system installation equipment needed by server (matrix controller), the client simply need a computer which can access the Internet.

### 3.4.3 Connection Diagram

System Connection is simple. Connect interface one-to-one, as shown in the following diagram:

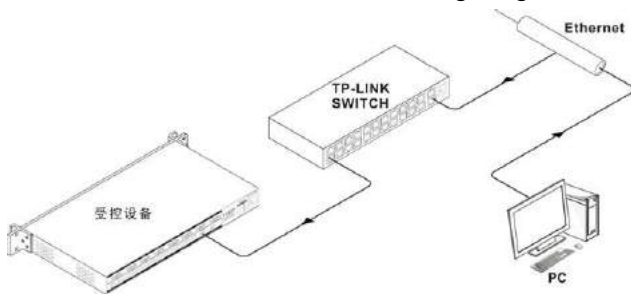

Figure 2-3

### 3.4.4 Instructions

The following instructions will choose "TP-link" router as an example to illustrate, as follows:

#### 3.4.4.1 Mapping Setup

A. After connecting system, open the IE browser, enter the IP address of TP-link and enter into the TP-link setup page. If the access is password-protected, enter the default user name: admin, password admin to enter.

For the first time into the TP-link setup interface, it default display the status of the TP-link information, see Figure 2-4 below.

Remote control system, TP-link routers only do port mapping settings, i.e. forwarding rules (common routers have this feature).



Figure 2-4

B. Select "forwarding rules" option on the left column of TP-link setting page, click on the "virtual server", and enter mapping settings page, as shown in Figure 2-5, this set operated as follows:

Click adding a new entry→fill the service port number, IP address, protocol, state→ save and exit, the setup is complete.

Service port number is the port number of the controlled device (matrix controller); IP address is the IP address of the controlled device (matrix controller);

Agreement can choose ALL or TCP protocol; state effective.



Figure 2-5



Figure 2-6

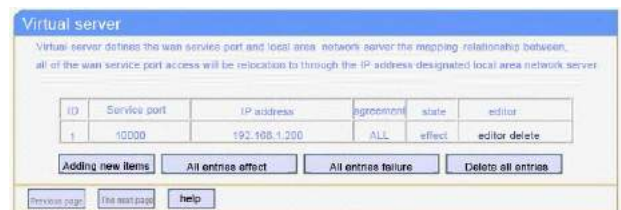



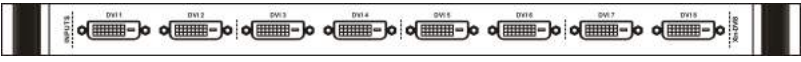



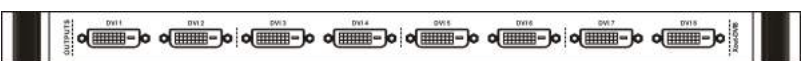





Figure 2-7

#### **3.4.4.2 Remote Bind Controlled Device Settings**

Before you can make the remote bind to the matrix controller, first you should know IP of public network connected by the matrix controller,. Only then, can you start setting. Set as follows:  
The client PC run TCP / UDP debugging software, create a TCP Client connection, fill in the IP address (i.e. the IP of public network connected by the matrix controller,), port number (i.e. the port number of matrix controller). After the successful setting, you can realize remote control of the matrix.

# Chapter 4 Input, Output Card Instructions

## 4.1 Card Type

Name / Model	Appearance
Xin-HDMI8 input card	
Xin-DVI8 input card	
Xin-CAT8 input card	
Xin-COMP8 input card	
Xin-SF8 input card	
Xout-HDMI8 output card	
Xout-DVI8 output card	
Xout-CAT8 output card	
Xout-SF8 output card	
FAN ASSEMBLY fan assembly card	
BC-100 blank card	
Radiating card	

## 4.2 Input Card

### 4.2.1 Xin-HDMI8 Input Card Function Characteristics

- ◆ 8 HDMI-A bus interface input;
- ◆ The longest input distance is up to 20M;
- ◆ Support EDID editing function;
- ◆ Is compatible with the HDMI1.4 standard, HDCP1.3 protocol, DVI1.0 protocol;
- ◆ Maximum support resolution:  
HDPC: 1920x1200P@60\_24bit;  
HDTV: 1920x1080P@60\_36bit;

### 4.2.2 Xin-DVI8 Input Card Function Characteristics

- ◆ 8 DVI-D bus interface input;
- ◆ The longest input distance is up to 20M;
- ◆ Support EDID editing function;
- ◆ Is compatible with the HDMI1.4 standard, HDCP1.3 protocol, DVI1.0 protocol;
- ◆ Maximum support resolution:  
HDPC: 1920x1200P@60\_24bit;  
HDTV: 1920x1080P@60\_36bit.

### 4.2.3 Xin-CAT8 Input Card Function Characteristics

- ◆ 8 high-speed RJ45 port input;
- ◆ The longest input distance is up to 100M byCAT5e/6 wire;
- ◆ Support EDID editing function;
- ◆ Is compatible with the HDBaseT protocol;
- ◆ Maximum support resolution:  
HDPC: 1920x1200P@60\_24bit;  
HDTV:1920x1080P@60\_36bit.

### 4.2.4 Xin-COMP8 Input Card Function Characteristics

- ◆ 8 DB15 port input;
- ◆ Can choose any kind of VGA, CVBS, YPbPr, S-Video signal input;
- ◆ Maximum support resolution:  
HDPC: 1920x1200P@60\_24bit;  
HDTV:1920x1080P@60\_36bit.
- ◆ Upscale output resolution can be set to up to 1920x1080P@60Hz.

### 4.2.5 Xin-SF8 Input Card Function Characteristics

- ◆ 8 high-speed single core SC fiber interface output;
- ◆ Using multimode fiber OM3 input, the longest distance up to300M;
- ◆ Maximum support resolution:  
HDPC: 1920x1200P@60\_24bit;  
HDTV:1920x1080P@60\_36bit.

## 4.3 Output Card

### 4.3.1 Xout-HDMI8 Output Card Function Characteristics

- ◆ 8 HDMI-A female interface output;
- ◆ The longest input distance is up to 7M;
- ◆ Is compatible with the HDMI1.4 standard, HDCP1.3 protocol, DVI1.0 protocol;
- ◆ Maximum support resolution:  
HDPC: 1920x1200P@60\_24bit;  
HDTV:1920x1080P@60\_36bit.

### 4.3.2 Xout-DVI8 Output Card Function Characteristics

- ◆ 8 DVI-D female interface output;
- ◆ The longest input distance is up to 7M;
- ◆ Is compatible with the HDMI1.4 standard, HDCP1.3 protocol, DVI1.0 protocol;
- ◆ Maximum support resolution:  
HDPC: 1920x1200P@60\_24bit;  
HDTV:1920x1080P@60\_36bit.

### 4.3.3 Xout-CAT8 Output Card Function Characteristics

- ◆ 8 high-speed RJ45 port output;;
- ◆ The longest input distance is up to 100M byCAT5e/6 wire;
- ◆ Maximum support resolution:  
HDPC: 1920x1200P@60\_24bit;  
HDTV:1920x1080P@60\_36bit.

### 4.3.4 Xout-SF8 Output Card Function Characteristics

- ◆ 8 high-speed single core SC fiber interface output;
- ◆ Using multimode fiber OM3 input, the longest distance up to300M;
- ◆ Maximum support resolution:  
HDPC: 1920x1200P@60\_24bit;  
HDTV:1920x1080P@60\_36bit.

## 4.4 Optional Accessories

### 4.4.1 FAN ASSEMBLY Function Characteristics

8 high-quality fans, replacing single fan or the whole fan card is optional, applicable to all series of CROSS-MAX matrix

### 4.4.2 BC-100 Blank Card Function Characteristics

- ◆ Blank card is used to fill the blank missing audio and video input / output card installation.

#### 4.4.3 PB-900 Power Supply Box Function Characteristics

- ◆ Universal full range AC input (AC100V-240V 50/60Hz);
- ◆ AC inrush current suppression circuit;
- ◆ With short / over load / over voltage / over temperature protection function;

Can provide 5V (425W), +12V (480W) power to the internal system;

Support redundant power cold backup, rapid replacement on scene.

### 4.5 Specifications

Model	Xin-DVI8(DVI input card)	Xout-DVI8(DVI input card)
<b>Specifications</b>		
Protocol		
Compatible with HDM11.3 standard, HDCPI.3 protocol, DVI I.0 protocol;.		
Video		
Gain	0 dB	
Pixel bandwidth	165MHz, Full digital	
Interface bandwidth	2.25Gbps, Full digital(a total of 6.75Gbps, each color is 2.25Gbps)	
Maximum support resolution	Normal-PC:1600x1200P@60_24bit,HDPC: 1920x1200P@60_24bit, HDTV:1920x1080P@60_36bit,	
Clock Jitter	<0.15T bit	
Rise time	<0.3Tbit (20%--80%)	
Fall time	<0.3Tbit (20%--80%)	
Maximum transmission delay	5nS(±1nS)	
Interface	8 DVI-D female interface / card	
Signal strength	T.M.D.S. +/- 0.4Vpp	
Minimum / maximum level	T.M.D.S. 2.9V/3.3V	
Impedance	50 Ω	
EDID	Optional default EDID and load function	N/A
Maximum DC offset error	15mV	

<b>Model</b>	<b>Xin-DVI8(DVI input card)</b>	<b>Xout-DVI8(DVI input card)</b>
<b>Specifications</b>		
The recommended maximum input / output distance	Less than 20 meters, in the 1920x1200@60 (recommended the use of certified DVI special wire. Such as Molex TM wire)	Less than 7 meters, in the 1600x1200@60 (recommended the use of certified DVI special wire. Such as Molex TM wire)
weight	About 0.5KG	About 0.5KG
Maximum power dissipation	12W	10W

<b>Model</b>	<b>Xin-HDMI8(HDMI input card)</b>	<b>Xout- HDMI 8(HDMI output card)</b>
<b>Specifications</b>		
<b>Protocol</b>		
Complete support for the HDMI1.4 protocol of 3D, including support for the mainstream of 3D display mode in HDM11.4 protocol, but does not include the 3D_1080P@120Hz downward compatible with HDM11.3 standard, HDCPI.3 protocol, DVII.0 protocol.		
<b>Video</b>		
Gain	0 dB	
Pixel bandwidth	165MHz, Full digital	
Interface bandwidth	2.25Gbps, Full digital(a total of 6.75Gbps, each color is 2.25Gbps)	
Maximum support resolution	HDPC: 1920x1200P@60_24bit, HDTV:1920x1080P@60_36bit, 3D Format: 1920x 1080P@24_36bit;	
Clock Jitter	<0.15T bit	
Rise time	<0.3Tbit (20%--80%)	
Fall time	<0.3Tbit (20%--80%)	
Maximum transmission delay	5nS(±1nS)	
Interface	8 HDMI-A female interface / card	
Signal strength	T.M.D.S. +/- 0.4Vpp	
Minimum / maximum level	T.M.D.S. 2.9V/3.3V	
Impedance	50 Ω	
EDID	Optional default EDID and load function	N/A
Maximum DC offset error	15mV	



<b>Model Specifications</b>	<b>Xin-HDMI8(HDMI input card)</b>	<b>Xout- HDMI 8(HDMI output card)</b>
The recommended maximum input / output distance	Less than 20 meters, in the 1920x1200@60 (recommended the use of certified DVI special wire. Such as Molex TM wire)	Less than 7 meters, in the 1920x1200@60 (recommended use certified HDMI special wire, such as Molex TM wire)
Weight	About 0.5KG	About 0.5KG
Maximum power dissipation	12W	10W

<b>Model Specifications</b>	<b>Xin-CAT8(Twisted pair input card)</b>	<b>Xout-CAT8(Twisted pair output card)</b>
Interface	8	
Link port input/output		
Interface	high-speed RJ45 Socket	
Supported protocols	HDBaseT protocol.	
Pixel bandwidth	165MHz ,full digital	
Interface bandwidth	2.25Gbps, full digital(a total of 6.75Gbps, each color is 2.25Gbps)	
Maximum support resolution	HDPC:1920x1200P@60_24bit; HDTV:1920x1080P@60_36bit; 3D Format:1920x 1080P@24_36bit.	
Signal type	High speed differential signal defined in HDBaseT protocol	
Cable transmission power	With PoE power supply (+12V); for CAT5 series transmitter of our company needing PoE power supply, this card can provide it power via cable. Note that this card cannot be connected to the transmitting device with PoE power.	With PoE power supply (+12V); for CAT5 series receiver of our company needing PoE power supply, this card can provide it power via cable. Note that this card cannot be connected to the receiving device with PoE power.
The recommended maximum input / output distance	Maximum distance is up to 100 meters, in 1920x1080p@60(Recommend the use of NEXANS CAT5e/6 special wire)	
Impedance	50 Ω	
EDID	Optional default EDID and load function	N/A
Maximum DC offset error	15mV	
The recommended maximum input / output distance	Less than 20 meters, in the1600x1200@60 (recommended the use of certified HDMI special wire. Such as Molex TM wire)	Less than 7 meters, in the1600x1200@60 (recommended the use of certified HDMI special wire. Such as Molex TM wire)
Weight	About 0.5KG	About 0.5KG

<b>Model</b>	<b>Xin-CAT8(Twisted pair input card)</b>	<b>Xout-CAT8(Twisted pair output card)</b>
<b>Specifications</b>		
Maximum power dissipation	12W	10W
The recommended maximum input / output distance	The maximum distance is up to 100 meters, in 1920x1080p@60(Recommend the use of NEXANS CAT5e/6/7 special wire)	
Weight	About 1.0KG	About 1.0KG
Maximum power dissipation	40W	21W

<b>Model</b>	<b>Xin-SF8( Optical fiber input card )</b>	<b>Xout-SF8( Optical fiber output card )</b>
<b>Specifications</b>		
interface	8 high-speed single core SC optical fiber interface input	
Video	Optical interface	SC connector
	Fiber type	Multimode/Single Mode(Optional)
	Wavelength	Multimode 850nm/Single Mode: 1310 –1620nm(Optional)
	Interface bandwidth	Positive:6.25Gbps, reverse:3.125Gbps
	Clock Jitter	<0.15Tbit
	Rise time	<0.3Tbit (20%--80%)
	Fall time	<0.3Tbit (20%--80%)
	The recommend ed maximum input / output distance	OM3 multimode optical fiber:less than 300 meters,Single-mode fiber: 2~20 km, at 1920x1080p@60
Maximum support resolution	HDPC: 1920x1200P@60_24bit, HDTV:1920x1080P@60_36bit,	
Weight	About 0.9KG	
Maximum power dissipation	24W	

<b>Model</b>	<b>Xin-COMP8</b>			
<b>Specifications</b>				
Interface	HD-15 Interface			
Signal type	Composite video CV	Y/C video	Component video YPbPr	VGA video
Gain	0dB	0dB	0 dB	0 dB
bandwidth	150MHz @ -3dB	150MHz @ -3dB	350MHz @ -3dB	380 MHz

<b>Model</b>	<b>Xin-COMP8</b>			
<b>Specifications</b>				
Differential phase error	0.1°,3.58-4.43 MHz	0.1°,3.58-4.43 MHz	0.1°,3.58-4.43 MHz	
Differential gain error	0.1% , 3.58-4.43 MHz	0.1% , 3.58-4.43 MHz	0.1% , 3.58-4.43 MHz	
Signal strength	1V p-p : composite video(CVBS)	1V p-p:S Terminal video (Y/C)	1V p-p :(Component video in Y) 0.3Vp-p: (Component video in PbPr/CbCr )	0.63V p-p to 0.9 V p-p
Minimum / maximum level	Analog signal: -2V/+2V	Analog signal: -2V/+2V	Analog signal: -2V/+2V	RGB signal:0V/1.0V HV signal:0V/5.0V
Input impedance	75 Ω	75 Ω	75Ω	75Ω
Echo loss	<-30dB@5MHz z	<-30dB@5MHz	<-30dB@5MHz	<-30dB@5MHz
Weight	About 1.2KG			
Maximum power dissipation	50W			

<b>Model</b>	<b>CROSS-MAX0808</b>	<b>CROSS-MAX1616</b>	<b>CROSS-MAX3232</b>
<b>Specifications</b>			
<b>Interface</b>			
Input card number / input channels	1/8	2/16	4/32
Output card number / output channels	1/8	2/16	4/32
Input card model	Xin-DVI8; Xin-HDMI8; Xin-CAT8; Xin-FB8; Xin-COMP8		
Output card model	Xout-DVI8; Xout-HDMI8; Xout-CAT8; Xout-FB8		
Interface bandwidth	6.75Gbps		
<b>Serial port control</b>			
Serial control interface	RS-232, 9- pin female D interface		
The baud rate and protocol	Baud rate: 9600, data bits: 8,stop bit : 1, no parity		
The serial control port structure	2 = TX,3 = RX,5 = GND		
<b>KEYBOARD control</b>			
KEYBOARD control	4 bit 3.8mm Phoenix interface		

<b>Model</b>	<b>CROSS-MAX0808</b>	<b>CROSS-MAX1616</b>	<b>CROSS-MAX3232</b>
<b>Specifications</b>			
Use	Use with the expansion keyboard MCP100		
KEYBOARD Control structure	+5V=DC5V , + = DATA+, -=DATA- GND = signal ground		
Ethernet control			
Ethernet control Interface:	RJ-45 female interface		
Ethernet control protocol	TCP/IP		
Ethernet Rate control	Adaptive 10m/100m, in full or half duplex		
Specifications			
Power supply	100VAC ~ 240VAC,50/60 Hz,The adaptive power supply		
Storage, use temperature	-20°~ +70°C		
Storage, use humidity	10% ~90%		
Dimension	3U[483mm(L)X354mm(W)X132.5mm(H)]	5U[483mm(L)X354mm(W)X221.5mm(H)]	10U[483mm(L)X404mm(W)X443.6mm(H)]
Weight	About 5.3KG(without any card)	About 9.0KG(without any card)	About 19KG(without any card)
Maximum power dissipation(studded with maximum power IO card)	107W	208W	383W
Mean time between failures	30,000 hours		
Warranty	1 year free warranty, life-long maintenance		

## Chapter 5 Instruction sets

Communication protocol

Baud rate :9600 bps(default)

Data bits:8bits

Stop bits:1bit

Parity:None

Flow control: None

Instruction symbols description

[Y1], [Y2],... , [Yn] represent the corresponding output ports

[TX1], [TX2],... , [TXn] represent the corresponding input serial port / infrared transmitting channels;

[RX1], [RX2],... , [RXn] represent the corresponding input serial port / infrared receiving channels;

[TY1], [TY2],... [TYn] represent the corresponding output serial port / infrared transmitting channels;

[RY1], [RY2],... [RYn] represent the corresponding output serial port / infrared receiving channels;

n represents the input / output interface quantity of corresponding model , such as CROSS-MAX3232, n is up to 32

**Instruction classification descriptions**

**Version:CREATOR 2.9**

**Build channel connection**

ASCII Instructions (Computer to the matrix)	Command functions	Return(matrix to computer)	For example
Establish a single connection			
[X1]V[Y1].	Audio and video input [X1] connected to audio and video output [Y1]	AV:[X1]->[ Y1]	1V1.
[X1]A[Y1].	Audio and video input [X1] connected to audio and video output [Y1]	AV:[X1]->[ Y1]	1A1.
[X1]B[Y1].	Audio and video input [X1] connected to audio and video output [Y1]	AV:[X1]->[ Y1]	1B1.
[RX1]R[TY1].	Serial receiving channel input port [RX1] connected to the serial port transmitting channel output [TY1] (RS232 forward channel switching)	RS:[RX1]->[TY1]	1R1.
[RX1]Q[TY1].	Infrared receiving channel input port [RX1] connected to the infrared transmitting channel output port [TY1] (IR forward channel switching)	IR:[RX1]->[TY1]	1Q1.
[RX1]T[TY1].	Serial Input port / infrared receiving channel [RX1] connected to the serial output port/ infrared transmitting channel [TY1] (RS232/IR forward and reverse channel switching)	RS:[RX1]->[TY1] IR:[RX1]->[TY1]	1T1.
[X1]W[Y1].	Audio and video input [X1] connected to audio and video output [Y1] serial Input port / infrared receiving channel [RX1] connected to the serial output port/ infrared transmitting channel	AV:[X1]->[ Y1] RS:[RX1]->[TY1] IR:[RX1]->[TY1]	1W1.

ASCII Instructions (Computer to the matrix)	Command functions	Return(matrix to computer)	For example
	[TY1](AV forward,RS232/IR forward and reverse channel switching)		
[RY1]~R[TX1].	Serial receiving channel Output port[RY1] connected to the serial transmitting channel input port[TX1] (RS232 reverse channel switching)	~RS:[RY1]->[TX1]	1~R2.
[RY1]~Q[TX1].	Infrared receiving channel output port[RY1] connected to the infrared transmitting channel input port [TX1] (IR reverse channel switching)	~IR: [RY1]->[TX1]	1~Q2.
[RY1]~T[TX1].	Serial output port / infrared receiver channel [RY1] connected to the serial input port / infrared transmitting channel [TX1] (RS232/IR reverse channel switching)	~RS:[RY1]->[TX1] ~IR: [RY1]->[TX1]	1~T2.
[X1]*[ Y1]&	Audio and video input [X1] connected to audio and video output [Y1]	AV:[X1]->[ Y1]	1*1&
[X1]*[ Y1]%	Audio and video input [X1] connected to audio and video output [Y1]	AV:[X1]->[ Y1]	1*1%
[X1]*[ Y1]\$	Audio and video input [X1] connected to audio and video output [Y1]	AV:[X1]->[ Y1]	1*1\$
[X1]*[ Y1]!	Audio and video input [X1] connected to audio and video output [Y1]	AV:[X1]->[ Y1]	1*1!
[X1]#.	Audio and video input [X1] connected to audio and video output [Y1] serial input port / infrared receiving channel[RX1]connected to the corresponding serial output port / infrared transmitting channel [TY1] serial output port / infrared receiving channel [RY1] connected to the corresponding serial input port / infrared transmitting channel [TX1]	[X1] AV/R/I Through.	1#.
Quickly establish multiplex connections			
[X1]V[Y1],[Y2],... ,[Yn].	One-way audio and video input[X1] connected to the multi-channel audio and video output [Y1],[Y2],...,[Yn]	AV:[X1]-> [Y1] AV:[X1]-> [Y2] ... AV:[X1]-> [Yn]	1V1,2,3.
[X1]A[Y1],[Y2],... ,[Yn].	One-way audio and video input[X1] connected to the multi-channel audio and video output [Y1],[Y2],...,[Yn]	AV:[X1]-> [Y1] AV:[X1]-> [Y2] ... AV:[X1]-> [Yn]	1A1,2,3.

ASCII Instructions (Computer to the matrix)	Command functions	Return(matrix to computer)	For example
[X1]B[Y1],[Y2],... ,[Yn].	One-way audio and video input[X1] connected to the multi-channel audio and video output [Y1],[Y2],..., [Yn]	AV:[X1]-> [Y1] AV:[X1]-> [Y2] ... AV:[X1]-> [Yn]	1B1,2,3.
[RX1]R[TY1], [TY2],..., [TYn].	One-way serial receiving channel input port [RX1] connected to the multi-channel serial port transmitting channel output [TY1], [TY2],..., [TYn] (RS232 forward multi-channel switching)	RS:[RX1]-> [TY1] RS:[RX1]-> [TY2] ... RS:[RX1]-> [TYn]	1R1,2,3.
[RX1]Q[TY1], [TY2],..., [TYn].	One-way infrared receiving channel input port [RX1] connected to the multi-channel infrared transmitting channel output port [TY1], [TY2],..., [TYn] (IR forward multi-channel switching)	IR:[RX1]-> [TY1] IR:[RX1]-> [TY2] ... IR:[RX1]-> [TYn]	1Q1,2,3.
[RX1]T[TY1], [TY2],..., [TYn].	One-way serial Input port / infrared receiveing channel [RX1] connected to the multi-channel serial output port/ infrared transmitting channel [TY1], [TY2],..., [TYn] (RS232/IR forward and reverse multi-channel switching)	RS:[RX1]->[TY1] IR:[RX1]->[TY1] RS:[RX1]-> [TY2] IR:[RX1]-> [TY2] ... RS:[RX1]-> [TYn] IR:[RX1]-> [TYn]	1T1,2,3.
[X1]W[Y1], [Y2],..., [Yn].	One-way audio and video input[X1] connected to the multi-channel audio and video output [Y1],[Y2],..., [Yn] one-way serial Input port / infrared receiving channel [RX1] connected to the multi-channel serial output port/ infrared transmitting channel [TY1], [TY2],..., [TYn] (AV forward,RS232/IR forward and reverse multi-channel switching)	AV:[X1]-> [Y1] RS:[RX1]->[TY1] IR:[RX1]->[TY1] AV:[X1]-> [Y2] RS:[RX1]-> [TY2] IR:[RX1]-> [TY2] ... AV:[X1]-> [Yn] RS:[RX1]-> [TYn] IR:[RX1]-> [TYn]	1W1,2,3.
[RY1]~R[TX1],[T X2],..., [TXn].	One-way serial receiving channel output port[RY1] connected to the multi-channel serial transmitting channel input port[TX1],[TX2],..., [TXn] (RS232 reverse channel switching)	~RS:[RY1]->[TX1] ~RS:[RY1]->[TX2] ... ~RS:[RY1]->[TXn]	1~R1,2,3.
[RY1]~Q[TX1],[T X2],..., [TXn].	One-way infrared receiving channel output port[RY1] connected to the multi-channel infrared transmitting channel input port [TX1] , [TX2],..., [TXn](IR reverse channel	~IR:[RY1]->[TX1] ~IR:[RY1]->[TX2] ... ~IR:[RY1]->[TXn]	1~Q1,2,3.

ASCII Instructions (Computer to the matrix)	Command functions	Return(matrix to computer)	For example
	switching)		
[RY1]~T[TX1],[TX2],...,[TXn].	One-way serial output port / infrared receiver channel [RY1] connected to the serial multi-channel input port / infrared transmitting channel [TX1],[TX2],...,[TXn] (RS232/IR reverse multi-channel switching)	~RS:[RY1]->[TX1] ~IR:[RY1]->[TX1] ~RS:[RY1]->[TX2] ~IR:[RY1]->[TX2] ... ~RS:[RY1]->[TXn] ~IR:[RY1]->[TXn]	1~T1,2,3.
[X1]All.	Audio and video input [X1] connected to all audio and video output one-way serial input port / infrared receiving channel[RX1]connected to all serial output port / infrared transmitting channel [TYn]	[X1] A/V/R/I To All	1All.
[X1],[X2],...,[Xn]#	Multi-channel audio and video input [X1],[X2],...,[Xn] connected to multi-channel audio and video output [Y1],[Y2],...,[Yn] multi-channel serial input port / infrared receiving channel[RX1],[RX2],...,[RXn] connected to the multi-channel corresponding serial output port / infrared transmitting channel [TY1],[ TY2],...,[ TYn] multi-channel serial output port / infrared receiving channel [RY1],[RY2],...,[RYn] connected to the multi-channel corresponding serial input port / infrared transmitting channel [TX1],[TX2],...,[TXn]	[X1] A/V/R/I Through. [X2] A/V/R/I Through. ... [Xn] A/V/R/I Through.	1,2,3#.
All#.	All audio and video input [Xn] connected to all corresponding audio and video output [Yn] all serial input port / infrared receiving channel[RXn]connected to the all corresponding serial output port / infrared transmitting channel [TYn] all serial output port / infrared receiving channel [RYn] connected to the all corresponding serial input port / infrared transmitting channel [TXn]	All A/V/R/I Through.	All#.

Note: All the switching instructions can be sent in multi-items and multi-types at the same time, such as (1V1.1R1.1Q2.2~R1.), matrix will first cache and then execute one by one



**Disconnect the channel connection**

ASCII Instructions (Computer to the matrix)	Command functions	Return(matrix to computer)	For example
Disconnect one-way connection			
0V[Y1].	Ddisconnect one-way audio and video output[Y1]	B:OFF->[Y1]!	0V1.
0A[Y1].	Disconnect one-way audio and video output[Y1]	B:OFF->[Y1]!	0A1.
0B[Y1].	Disconnect one-way audio and video output[Y1]	B:OFF->[Y1]!	0B1.
0R[TY1].	Disconnect one-way serial output port [TY1]	RS:OFF->[TY1]!	0R1.
0Q[TY1].	Disconnect one-way infrared receiving channel output port [TY1]	IR:OFF->[TY1]!	0Q1.
0T[TY1].	Disconnect one-way serial output port / infrared transmitting channel [TY1]	RS:OFF->[TY1]! IR:OFF->[TY1]!	0T1.
0W[Y1].	Disconnect one-way audio and video output[Y1]and serial output port / infrared transmitting channel[TY1]	B:OFF->[ Y1]! RS:OFF->[TY1]! IR:OFF->[TY1]!	0W1.
0~R[TX1].	Disconnect one-way serial input port [TX1]	~RS:OFF->[TX1]!	0~R1.
0~Q[TX1].	Disconnect one-way infrared transmitting channel output port [TX1]	~IR:OFF->[TX1]!	0~Q1.
0~T[TX1].	Disconnect one-way serial input port / infrared transmitting channel [TX1]	~RS:OFF->[TX1]! ~IR:OFF->[TX1]!	0~T1.
0*[Y1]&	Disconnect one-way audio and video output [Y1]	B:OFF->[Y1]!	0*1&
0*[Y1]%	Disconnect one-way audio and video output [Y1]	B:OFF->[Y1]!	0*1%
0*[Y1]\$	Disconnect one-way audio and video output [Y1]	B:OFF->[Y1]!	0*1\$
0*[Y1]!	Disconnect one-way audio and video output [Y1]	B:OFF->[Y1]!	0*1!
[Y1]\$.	Disconnect one-way audio and video output [Y1]	B:OFF->[Y1]!	1\$.
Quickly disconnect multiplex connections			
[Y1],[Y2],...,[Yn]\$.	Disconnect multiplex audio and video output [Y1],[Y2],...,[Yn]	B:OFF->[Y1]! B:OFF->[Y2]! ... B:OFF->[Yn]!	1,2,3\$.
[TY1],[TY2],...,[TYn]R\$.	Disconnect multi-channel serial output port [TY1],[TY2],...,[TYn]	RS:OFF->[TY1]! RS:OFF->[TY2]!	1,2,3R\$.

		... RS:OFF->[TYn]!	
[TY1],[TY2],..., [TYn]Q\$.	Disconnect multi-channel infrared transmitting channel output port [TY1],[TY2],..., [TYn]	IR:OFF->[TY1]! IR:OFF->[TY2]! ... IR:OFF->[TYn]!	1,2,3Q\$.
[TY1],[TY2],..., [TYn]T\$.	Disconnect multi-channel serial output port/ infrared transmitting channel [TY1],[TY2],..., [TYn]	RS:OFF->[TY1]! IR:OFF->[TY1]! RS:OFF->[TY2]! IR:OFF->[TY2]! ... RS:OFF->[TYn]! IR:OFF->[TYn]!	1,2,3T\$.
[Y1],[Y2],..., [Yn]W\$.	Disconnect multiplex audio and video output [Y1],[Y2],..., [Yn] Disconnect multi-channel serial output port/ infrared transmitting channel [TY1],[TY2],..., [TYn]	B:OFF->[Y1]! RS:OFF->[TY1]! IR:OFF->[TY1]! B:OFF->[Y2]! RS:OFF->[TY2]! IR:OFF->[TY2]! ... B:OFF->[Yn]! RS:OFF->[TYn]! IR:OFF->[TYn]!	1,2,3W\$.
[TX1],[TX2],..., [TXn]~R\$.	Disconnect multi-channel serial transmitting channel input port [TX1],[TX2],..., [TXn]	RS:OFF->[TX1]! RS:OFF->[TX2]! ... RS:OFF->[TXn]!	1,2,3~R\$.
[TX1],[TX2],..., [TXn]~Q\$.	Disconnect multi-channel infrared transmitting channel input port [TX1],[TX2],..., [TXn]	IR:OFF->[TX1]! IR:OFF->[TX2]! ... IR:OFF->[TXn]!	1,2,3~Q\$.
[TX1],[TX2],..., [TXn]~T\$.	Disconnect multi-channel serial Input port / infrared transmitting channel [TX1],[TX2],..., [TXn]	RS:OFF->[TX1]! IR:OFF->[TX1]! RS:OFF->[TX2]! IR:OFF->[TX2]! ... RS:OFF->[TXn]! IR:OFF->[TXn]!	1,2,3~T\$.
All\$.	Disconnect all audio and video[Yn] and serial input/output port / nfrared transmitting channel [TXn],[TYn]	All A/V/R/I Closed.	All\$.

**Inquire channel connection**

ASCII Instructions (Computer to the matrix)	Command functions	Return(matrix to computer)	For example
Status[X1],[X2],..., [Xn].	Inquire connection status of one-way or multiplex audio and video input[X1],[X2],..., [Xn]	A:[X1]->[Yn] V:[X1]->[Yn] ... A:[X2]->[Yn] V:[X2]->[Yn] ... A:[Xn]->[Yn] V:[Xn]->[Yn] ...	Status1,2,3.
Inquire[X1],[X2],..., [Xn].	Inquire connection status of serial input port /infrared receiving channel [RX1],[RX2],..., [RXn] and transmitting output channel[TY1],[TY2],..., [TXn] and serial output port/infrared receiving channel [RY1],[RY2],..., [RYn]and transmitting input channel[TX1],[TX2],..., [TXn] (inquire connection status of RS232/IR bidirectional channels)	RS:[RX1]->[TYn] IR:[RX1]->[TYn] ... RS:[RX2]->[TYn] IR:[RX2]->[TYn] ... RS:[RXn]->[TYn] IR:[RXn]->[TYn] ... ~RS:[RY1]->[TXn] ~IR:[RY1]->[TXn] ... ~RS:[RY2]->[TXn] ~IR:[RY2]->[TXn] ... ~RS:[RYn]->[TXn] ~IR:[RYn]->[TXn] ...	Inquire1,2,3.
Status.	Inquire connection status of all audio and video output	A:[X1]->[Yn] V:[X1]->[Yn] ... A:[X2]->[Yn] V:[X2]->[Yn] ... A:[Xn]->[Yn] V:[Xn]->[Yn] ...	Status.
Inquire.	Inquire connection status of all bidirectional serial / infrared channels	RS:[RX1]->[TYn] IR:[RX1]->[TYn]	Inquire.

ASCII Instructions (Computer to the matrix)	Command functions	Return(matrix to computer)	For example
		... RS:[RX2]->[TYn] IR:[RX2]->[TYn] ... RS:[RXn]->[TYn] IR:[RXn]->[TYn] ... ~RS:[RY1]->[TXn] ~IR:[RY1]->[TXn] ... ~RS:[RY2]->[TXn] ~IR:[RY2]->[TXn] ... ~RS:[RYn]->[TXn] ~IR:[RYn]->[TXn] ...	

**Global pre-set instructions**

ASCII Instructions (Computer to the matrix)	Command functions	Return(matrix to computer)	For example
Save[N].	N=1,2,3,...,8. Save the connection state of all audio and video / serial / infrared to the N global setting	Save To F[N]	Save2.
Recall[N].	Recall from the N global pre-set as the current connection state	Recall From F[N]	Recall2.
Clear[N].	Clear the N global default and its name	Clear F[N]	Clear2.

**Security Settings instructions**

ASCII Instructions (Computer to the matrix)	Command functions	Return(matrix to computer)	For example
/%Lock;	Lock the control panel keyboard	System Locked!	/%Lock;
/%Unlock;	Unlock the control panel keyboard	System Unlocked!	/%Unlock;

**Note: the panel can be locked or unlocked only by serial command.**

System Settings instructions

ASCII Instructions (Computer to the matrix)	Command functions	Return(matrix to computer)	For example
/:BellOff;	Close the bell	Closed The Bell.	/:BellOff;
/:BellOn;	Open the bell	Opened The Bell.	/:BellOn;
/:MessageOff;	Closed the message return	Closed The Message Return.	/:MessageOff ;
/:MessageOn;	Enabled the message return.	Enabled The Message Return.	/:MessageOn ;

**Permission instruction**

ASCII Instructions (Computer to the matrix)	Command functions	Return(matrix to computer)	For example
[X1]H[Y1],[Y2],...[Yn].	Audio and video input [X1] prohibit to output from[Y1],[Y2],...[Yn] channel	AV: [X1]![>[Y1] SetForbidOK! AV: [X1]![>[Y2] SetForbidOK! ... AV: [X1]![>[Yn] SetForbidOK!	1H1,2,3.
[X1]F[Y1],[Y2],...[Yn].	Audio and video input [X1] prohibit to output from[Y1],[Y2],...[Yn] channel	AV: [X1]![>[Y1] SetForbidOK! AV: [X1]![>[Y2] SetForbidOK! ... AV: [X1]![>[Yn] SetForbidOK!	1F1,2,3.
QueryH[X1],[X2],...[Xn].	Query the status that one-way or multiplex audio and video cannot be output from which output channel.	A: [X1]![>[Yn] ! V: [X1]![>[Yn] ! ... A: [X2]![>[Yn] ! V: [X2]![>[Yn] ! ... A: [Xn]![>[Yn] ! V: [Xn]![>[Yn] ! ...	QueryH1,2,3.
QueryF[X1],[X2],...[Xn].	Query the status that one-way or multiplex audio and video cannot be output from which output channel	A: [X1]![>[Yn] ! V: [X1]![>[Yn] ! ... A: [X2]![>[Yn] ! V: [X2]![>[Yn] ! ... A: [Xn]![>[Yn] ! V: [Xn]![>[Yn] ! ...	QueryF1,2,3.
EliminateH[X1],[X2],...[Xn].	Cancel the corresponding output inhibition of audio and video input	AV:[X1] InputEliminateForbidOK!	EliminateH1,2,3.

ASCII Instructions (Computer to the matrix)	Command functions	Return(matrix to computer)	For example
	channels[X1], [X2]...[Xn],namely, [X1], [X2],... [Xn] are designated to be output from any output channels	AV:[X2] InputEliminateForbidOK! ... AV:[Xn] InputEliminateForbidOK!	
EliminateF[X1], [X2],...[Xn]..	Cancel the corresponding output inhibition of audio and video input channels[X1], [X2]...[Xn],namely, [X1], [X2],... [Xn] are designated to be output from any output channels	AV:[X1] InputEliminateForbidOK! AV:[X2] InputEliminateForbidOK! ... AV:[Xn] InputEliminateForbidOK!	EliminateF1,2,3.
EliminateHAll.	All audio and video input channel permissions restore to their default values, hey can be put out from any output channel.	AllVEliminateForbidOK!	EliminateH All.
EliminateFAIl.	All audio and video input channel permissions restore to their default values, hey can be put out from any output channel.	AllAEliminateForbidOK!	EliminateFA Il.

### Network Settings

ASCII Instructions (Computer to the matrix)	Command functions	Return(matrix to computer)	For example
<#SPORT[5000]>	Set matrix port	SPORT:[5000]	<#SPORT5000>
<#SIPR[192]. [168]. [0]. [2]>	Set matrix IP	SIPR:[192].[168].[0].[2]	<#SIPR192.168.0.2>
<#GAR [192]. [168]. [0]. [1]>	Set matrix gateway	GAR:[192].[168].[0].[1]	<#GAR192.168.0.1>
<#SUBR [255]. [255]. [255]. [0]>	Set matrix subnet mask	SUBR:[255].[255].[255].[0]	<#SUBR255.255.255.0>
<# SHAR 0x[00]. 0x[11]. 0x[22]. [0x33]. [0x44]. [0x55]>	Set network hardware address (network hardware address 16 hex)	0x[00]. 0x[11]. 0x[22]. [0x33]. [0x44]. [0x55]>	<#SHAR0x00.0x11.0x22.0x33.0x44.0x55>
<#NETDEFAULT>	Restore the default network configuration	NETDEFAULT:[OK]	<#NETDEFAULT>

ASCII Instructions (Computer to the matrix)	Command functions	Return(matrix to computer)	For example
	Set network error	Out of range!	
	Set network successfully	NETSET:OK	

**Note:** it will return to "Out of range!" when set network error and returns "NETSET: OK." when set network successfully

### System inquiry instructions

ASCII Instructions (Computer to the matrix)	Command functions	Return(matrix to computer)	For example
/^Version;	Inquiry matrix system version	[X4]	/^Version;
/*Type;	Inquiry matrix type	[X5]	/*Type;
<^SPORT>	Inquiry matrix port	SPORT:[X12]	<^SPORT>
<^SIPR>	Inquiry matrix IP	SIPR:[X12].[X13].[X14].[X15]	<^SIPR>
<^SUBR>	Inquiry matrix subnet mask	SUBR:[X12].[X13].[X14].[X15]	<^SUBR>
<^GAR>	Inquiry matrix gateway	GAR:[X12].[X13].[X14].[X15]	<^GAR>
<^SHAR>	Inquiry matrix hardware address	SHAR:[X12].[X13].[X14].[X15].[X16].[X17]	<^SHAR>

### Common settings command

ASCII Instructions (Computer to the matrix)	Command functions	Return(matrix to computer)	For example
Standardswitch.	Switch to standard mode	STANDARD SWITCH!	Standardswitch.
Fastswitch.	Switch to a fast mode (default)	FASTSWITCH!	Fastswitch.
RWEDID.	Load the first output port of the EDID to all input port	EDID-OK!( success) EDID-FAIL!(Failure)	RWEDID.
DefaultEDID.	Restore the system default EDID to all input port	EDID-OK!	DefaultEDID.
[Y1]D[X1], [X2],...[Xn].	Read the monitor EDID connected to port [Y1] to the input port [X1], [X2],... , [Xn]. When the output port [Y1] equals 0,it means that restores the default EDID to the corresponding input port	EDID-OK!( success) EDID-FAIL!(Failure)	1D1,2,3,8.

ASCII Instructions (Computer to the matrix)	Command functions	Return(matrix computer) to	For example
	1D1,2,3,4,5,6,7,8.) As input ports [Xn] are required in the same layer of the input card, so only 8 roads can be written at one time (for example: 1D1,2,3,4,5,6,7,8.)		

**COMP8 input and output card control instruction table**

ASCII Instructions (Computer to the matrix)	Command functions	Return(matrix computer) to	For example
COMP8 card commands - set active command to card port (Note: Activate the card port before the corresponding port parameter settings)			
[X1],[X2],..., [Xn] SETIN.	Enter the input card debugging mode, activate the port of COMP8 input card (the maximum number is up to 40) and it will automatically exit debugging mode without any operation in 10 minutes. Note: Only one input port can be activated during query; output card debugging mode automatically exit after the use of the command, and the port activated by input card debugging mode automatically become invalid .	Command OK!	1,2,3,4SETI N.
[Y1],[Y2],..., [Yn] SETOUT.	Enter the output card debugging mode, activate the port of COMP8 output card (the maximum number is up to 40) and it will automatically exit debugging mode without any operation in 10 minutes. Note: Only one output port can be activated during query; input card debugging mode automatically exit after the use of the command, and the port activated by output card debugging mode automatically become invalid .	Command OK!	1,2,3,4SETO UT.
EXITSET.	Exit component card debugging mode state	Command OK!	EXITSET.
COMP8 card commands - video switching operation instruction			
01C02.	Set the active port to CV video mode	Command OK!	01C02.
03C02.	Set the active port to YPbPr video mode	Command OK!	03C02.



ASCII Instructions (Computer to the matrix)	Command functions	Return(matrix to computer)	For example
05C02.	Set the active port to VGA video mode	Command OK!	05C02.
12C02.	Set the active port to YC video mode	Command OK!	12C02.
COMP8 card command -output the resolution operation instruction			
01C08.	Set the active port resolution to 800 x 600@60Hz	RESOLUTION:1	01C08.
02C08.	Set the active port resolution to 1024x768@60Hz	RESOLUTION:2	02C08.
03C08.	Set the active port resolution to 1280x720@60Hz	RESOLUTION:3	03C08.
04C08.	Set the active port resolution to 1280x800@60Hz	RESOLUTION:4	04C08.
05C08.	Set the active port resolution to 1280x1024@60Hz	RESOLUTION:5	05C08.
07C08.	Set the active port resolution to 1400x1050@60Hz	RESOLUTION:7	07C08.
08C08.	Set the active port resolution to 1440x900@60Hz	RESOLUTION:8	08C08.
09C08.	Set the active port resolution to 1600x900@60Hz	RESOLUTION:9	09C08.
011C08.	Set the active port resolution to 1680x1050@60Hz	RESOLUTION:11	11C08.
012C08.	Set the active port resolution to 1920x1080@60Hz	RESOLUTION:12	12C08.
013C08.	Set the active port resolution to custom resolution	RESOLUTION:13	13C08.
COMP8 card commands - OSD menu operation instruction output to the screen			
01C15.	Enter the OSD menu settings	Command OK!	01C15.
02C15.	Exit the OSD menu settings	Command OK!	02C15.
03C15.	The OSD menu leftward setting	Command OK!	03C15.
04C15.	The OSD menu rightward setting	Command OK!	04C15.
07C15.	Automatically adjust the screen settings	Command OK!	07C15.
08C15.	Automatically adjust function enable	Command OK!	08C15.
09C15.	Automatically adjust function inhibition	Command OK!	09C15.
xxC21.	Adjust the brightness parameter (00<=xx<=99)	Command OK!	xxC21.
xxC22.	Adjust the contrast parameter	Command OK!	xxC22.

ASCII Instructions (Computer to the matrix)	Command functions	Return(matrix computer) to	For example
	(00<=xx<=99)		
xxC23.	Adjust the parameters of saturation (00<=xx<=99)	Command OK!	xxC23.
xxC24.	Adjust the phase parameter (00<=xx<=99)	Command OK!	xxC24.
xxC25.	Adjust the clock parameters (00<=xx<=99)	Command OK!	xxC25.
xxC26.	Adjust the horizontal position parameter (00<=xx<=99)	Command OK!	xxC26.
xxC27.	Adjust the vertical position parameter (00<=xx<=99)	Command OK!	xxC27.
COMP8 card commands - query recovery operation instruction			
01C30.	Query the input channel corresponding to the current video output	Video Source:xx	01C30.
06C30.	Query the current active port resolution	RESOLUTION:xx	06C30.
09C30.	Restore the current active port to factory settings	Command OK!	09C30.

### Network default parameters

Matrix port:5000
Matrix IP:192.168.0.2
Matrix gateway:192.168.0.1
Matrix subnet mask:255.255.255.0
Matrix hardware address:0x00.0x11.0x22.0x33.0x44.0x55;

**Note: The network parameters come into effect only after restarting the matrix system.**

1.RS-232 and IR panel operation are forward (forward: input connect RS-232 or IR sender, output connect RS-232 or IR receiver);

2.RS-232 and IR reverse switch to toggle through the machine's serial instruction (reverse: input connected to RS-232 or IR receiver, output connected to the RS-232 or infrared sender) please View serial instructions for serial switcher instruction.

3.NO matter forward or reverse switch of infrared and serial signal, one way can be switched to another or more ways, multiple ways cannot be switched at the same time to one way.

CREATOR CORPORATION(CHINA)  
Copyright by CREATOR

Last Revision:08/2013