



**CREATOR<sup>®</sup> 快捷**

CREATOR CORPORATION (CHINA)

User's manual of DIG series  
Full digital conference system







V2.2 version

CREATOR COOPERATION(CHINA)

# Meaning of symbols

## ■ safety instructions

For your safe and correct use of equipment, we use a lot of symbols on the equipment and in the manuals, demonstrating the risk of body hurt or possible damage to property for the user or others. Indications and their meanings are as follow. Please make sure to correctly understand these instructions before reading the manual.

	<p>This is A level product, which may cause radio interference in the living environment. In this case, users may need to take the feasible measures to get around the interference.</p>
	<p>Remind users that the dangerous voltage Without insulation occurring within the equipment may cause people suffer from shock</p>
	<p>CE certification means that the product has Reached the directive safety requirements defined by the European Union. Users can be assured about the use of it</p>
	<p>SGS certification means that the product has reached the quality inspection standards proposed by the world's largest SGS.</p>
	<p>This product passed the ISO9001 international quality certification (certification body: TUV Rheinland, Germany).</p>
	<p>Warning: in order to avoid electrical shock, do not open the machine cover, nor is the useless part allowed to be placed in the box. Please contact the qualified service personnel.</p>

## ■ General information instructions

	<p>It lists the factors leading to the unsuccessful operation or set and the relevant information to pay attention to.</p>
---	--

# Important notices



warning

In order to ensure the reliable performance of the equipment and the safety of the user, please observe the following matters during the process of installation, use and maintenance:

## **The matters needing attention of installation**

- ◆ Please do not use this product in the following places: the place of dust, soot and electric conductivity dust, corrosive gas, combustible gas; Matters needing attention during operation and maintenance the place exposed to high temperature, condensation, wind and rain; the occasion of vibration and impact. Electric shock, fire, wrong operation can lead to damage and deterioration to the product, either;
- ◆ in processing the screw holes and wiring, make sure that metal scraps and wire head will not fall into the shaft of controller, as it could cause a fire, fault, or incorrect operation;
- ◆ when the installation work is over, it should be assured there is nothing on the ventilated face, including packaging items like dust paper. Otherwise this may cause a fire, fault, incorrect operation for the cooling is not free,;
- ◆ Should avoid wiring and inserting cable plug in charged state, otherwise it is easy to cause the shock, or electrical damage;
- ◆ The installation and wiring should be strong and reliable, contact undesirable may lead to false action,;
- ◆ For a serious interference in applications, should choose shield cable as the high frequency signal input or output cable, so as to improve the anti-jamming ability of the system.

## **Attention in the wiring**

- ◆ Only after cutting down all external power source, can install, wiring operation begin, or it

may cause electric shock or equipment damage;

- ◆ This product grounds by the grounding wires. To avoid electric shocks, grounding wires and the earth must be linked together. Before the connection of input or output terminal, please make sure this product is correctly grounded;
- ◆ Immediately remove all other things after the wiring installation. Please cover the terminals of the products cover before electrification so as to avoid cause electric shock;

## **Matters needing attention during operation and maintenance.**

- ◆ Please do not touch terminals in a current state, or it may cause a shock, incorrect operation,;
- ◆ Please do cleaning and terminal tighten work after turning off the power supply. These operations can lead to electric shock in a current state;
- ◆ Please do the connection or dismantle work of the communication signal cable, the expansion module cable or control unit cable after turning off the power supply, or it may cause damage to the equipment, incorrect operation;
- ◆ Please do not dismantle the equipment, Avoid damaging the internal electrical component.
- ◆ Should be sure to read the manual, fully confirm the safety, only after that can do program Changes commissioning, start and stop, operation

## **Matters needing attention in discarding**

## product

◆electrolytic explosion:the burning of electrolytic capacitor on circuit boards may lead to explosion;

◆ please collect and process according to the classification, do not put into life garbage;

◆ please process it as industrial waste, or According to the local environmental protection regulations.

## preface

Full Digital conference system User's Manual mainly introduces the operation method of CR-DIG5201-A、CR-DIG5202A2、CR-DIG5204A2、CR-DIG5202B2、CR-DIG5204B2、CR-DIG5202D2、CR-DIG5204D2 、 CR-DIG5202C1 、 CR-DIG5204C1 、 CR-DIG5202C2 、 CR-DIG5204C2 、 CR-DIG5206CH、CR-DIG5207SP 、 CR-DIG5202C1-S、CR-DIG5204C1-S、CR-DIG5202C2-S、CR-DIG5204C2-S 、 CR-DIG5206CH-S、CR-DIG5205DS 、 CR-DIG5205DS-S 、 CR-DIG52032BOX、CR-DIG5203E3 、 CR-DIG5200EXP 、 CR-DIG5202E1 、 CR-DIG5204E1 、 CR-DIG5202E2 、 CR-DIG5204E2 、 CR-DIG5202E3 、 CR-DIG5204E3 、 CR-DIG5202C1-C 、 CR-DIG5204C1-C 、 CR-DIG5202C2-C、CR-DIG5204C2-C 、CR-DIG5206CH-C、CR-CAT5BOX02/04、CR-CAT5202/4C1、CR-CAT5202/4C2、CR-CAT5206CH、CR-CAT5207SP Their main performance parameters and common fault solutions.

This manual is only used as user instruction, not for a repair service usage. The functions or related parameters may be changed since the date of issue, please inquire the supplemental information from CREATOR Electronics or local distributors.

The copyright of this manual belongs to CREATOR Electronics. Without permission, no unit or individual shall adopt part or all of its content for commercial use.

The manual is protected by of the Copyright Law of the Peoples Republic of China and other regulations about intellectual property rights. Without written permission shall not be copied or distributed.

# Index

Chapter 1.summary.....	1
Chapter 2.conference controller.....	2
2.1 CR-DIG5201-A.....	2
2.1.1 features .....	2
2.1.2 host installation .....	3
2.1.3 panel description.....	4
2.1.4 description of the ports.....	6
2.1.4.1 CONTROL SYSTEM——RS-232 port.....	6
2.1.4.2 productions methods of ETHERNET RJ45 cable .....	7
2.1.5 Menu software instructions .....	7
2.1.5.1 option instructions .....	8
2.1.5.1.1 “connection”option.....	8
2.1.5.1.2 “conference host”option.....	8
2.1.5.1.3 “unit manage”option .....	8
2.1.5.1.4 “language”option .....	9
2.1.5.1.5 “exit”option.....	9
2.1.5.2 connection and "read configuration "instructions .....	9
2.1.5.3 “conference management” configuration instructions .....	9
2.1.5.3.1 mic mode .....	9
2.1.5.3.2 the number of mic.....	10
2.1.5.3.3 system language .....	10
2.1.5.4 “audio setting”configuration instructions.....	10
2.1.5.4.1 DSP sound setting and the switch of speaker .....	10
2.1.5.4.2 volume control .....	10
2.1.5.4.3 sound field choice.....	11
2.1.5.5 canera setting .....	11
2.1.5.5.1 camera protocol.....	11
2.1.5.5.2 camera mapping.....	11
2.1.5.5.3 camera setting.....	11
2.1.5.6 translation setting.....	12
2.1.5.6.1 auto channel.....	12
2.1.5.6.2 total channel .....	12
2.1.5.6.3 translate roon setting.....	12
2.1.5.6.4 lock channel.....	12
2.1.5.6.5 channel language .....	12
2.1.5.7 speaker partition setting .....	13
2.1.5.7.1 speaker partition setting open /close .....	13
2.1.5.7.2 mic district division .....	13
2.1.5.7.3 speaker district gain control .....	13
2.1.6 double-machnice hot backuo setting .....	14
2.1.7 technical parameters.....	14
2.1.8 system connection diagram .....	15

Chapter 3.conference system unit .....	18
3.1 translation unit .....	18
3.1.1 features .....	18
3.1.2 panel description .....	18
3.1.3 descriptions of panel display .....	19
3.1.4 operator .....	19
3.1.5 technical parameters .....	20
3.1.6 system connection diagram .....	21
3.2 conference system product classification .....	22
3.2.1 CR-DIG5202/4A2 speech unit .....	27
3.2.1.1 features .....	27
3.2.1.2 panel description .....	28
3.2.1.3 technical parameters .....	28
3.2.2 CR-DIG5202/4B2 speech unit .....	29
3.2.2.1 features .....	29
3.2.2.2 panel description .....	29
3.2.2.3 technical parameters .....	31
3.2.3 desktop speech unit .....	31
3.2.3.1 features .....	31
3.2.3.2 panel description .....	32
3.2.3.3 technical parameters .....	33
3.2.4 CR-DIG5202/4D2 speech unit .....	34
3.2.4.1 features .....	34
3.2.4.2 panel description .....	34
3.2.4.3 technical parameters .....	35
3.2.5 embedded unit .....	35
3.2.5.1 features .....	35
3.2.5.2 apperance size chart .....	35
3.2.5.3 installtion instruction .....	36
3.2.5.4 panel description .....	37
3.2.5.5 technical parametes .....	38
3.2.6 embedded unit II generation .....	39
3.2.6.1 touch .....	39
3.2.6.1 1 features .....	39
2.2.6.1.2 apperance size chart .....	39
3.2.6.1.3 installation instruction .....	40
3.2.6.1.4 panel description .....	42
2.2.6.1.5 technical parameters .....	43
3.2.6.2 button .....	44
3.2.6.2.1 features .....	44
3.2.6.2.2 apperance size chart .....	44
3.2.6.2.3 installation instruction .....	45
2.2.6.2.5 technical parameters .....	48
3.2.7 embedded speech unit CAT5 interface .....	49

3.2.7.1	features .....	49
3.2.7.2	apperance size chart .....	50
3.2.7.3	installation instruction .....	50
3.2.7.4	panel description.....	53
3.2.7.5	technical parameters .....	54
3.2.8	CR-CAT5BOX02/04 embedded connection box CAT5 interface .....	55
3.2.8.1	features .....	55
3.2.8.2	panel instruction.....	55
3.2.8.3	technical parameters .....	55
3.2.9	VFD display unit .....	56
3.2.9.1	features .....	56
3.2.9.2	description of apperance button .....	56
3.2.9.3	technical parametes.....	57
3.3	VFD disply unit managment sofeware .....	57
3.3.1	features .....	57
3.3.2	software interface and operating instructions .....	57
3.3.2.1	venues management .....	58
3.3.2.2	tea application .....	60
3.3.2.3	short message sending .....	60
3.4	system connection diagram .....	61
Chapter 4	conference system connection box.....	64
4.1	DIG52032BOX system connection box .....	64
4.1.1	features .....	64
4.1.2	panel instruction .....	64
4.1.3	technical parapeters.....	65
4.1.4	system connection diagram .....	66
4.2	active expand connection box.....	66
4.2.1	features .....	67
4.2.2	descriptions of panel function .....	67
4.2.3	technical parameters.....	67
4.2.4	system connection diagram .....	67
Chapter 5	examples of speech unit operations.....	68
5.1	lanch sign in.....	69
5.1.1	chairman lanch sign in .....	69
5.2	lanch vote .....	69
5.2.1	chairman lanch vote.....	69
5.2.2	PC lanch vote .....	70
5.3	microphone management .....	70
5.3.1	speech mode.....	70
5.3.2	apply spech .....	71
5.3.3	Stop speech. ....	71
5.3.4	The biggest statements.....	71
5.3.5	Speeching .....	71
5.4	Services.....	71

5.4.1	language settings .....	71
5.4.2	Intercom .....	72
5.4.3	Tea.....	72
5.4.4	Message.....	72
Chapter 6、	Accessories.....	73
6.1	CR-P2 Earphone (no mic) .....	73
6.1.1	Function description.....	73
6.1.2	Technical parameters.....	74
6.2	CR-P4 earmuffs with microphone headse .....	74
6.2.1	Function description.....	74
6.2.2	technical parameters.....	75
6.3	CR-M4KL415Knob 415mm MIC Stand.....	75
6.4	CR-CT20 conference desktop sockets .....	75
6.5	CR-CT30 pop-up conference socket. ....	75
6.6	CR-CT50 8 core air interface.....	76
6.7	Installation of cables.....	76



## Chapter1、 summary

The CREATOR Full digital conference system, is another high-tech professional product series following multimedia control products and audio and video matrix products, including systems of discussions and statements, simultaneous interpretation, infrared voice allocation, remote conference call, the vote, the electronic table card, camera tracking, etc.

Adhering to the concept of comprehensive system integration solutions which the CREATOR Has always advocated,CREATOR can achieve close compatibility between two different systems Namely digital conferencing systems and multimedia central control system, thus compose a comprehensive intelligent conferencing solution by CREATOR products.

The Full digital conference system is the fifth-generation CREATOR conferencing products, and all aspects have been upgraded. Specifically,the system stability, ease of operability and so have been further improved.

This manual applies to control host unit of speech, the camera tracking system, teleconferencing systems, and infrared voice distribution system of the CREATOR full digital conference system.

## Chapter2、 conference controller

### 2.1 CR-DIG5201-A

CR-DIG5201 full digital conference host is a core part of the all digital conference system, set to vote, microphone management, cable simultaneous, electronic card tables high-throughput data processing in one, using feedback suppression, noise reduction, automatic gain, digital equalizerDSP processing technology. Support a variety of conference mode selection, suitable for all types of meetings. full digital conference host can be installed in standard 19 in. rack, easy to store and custody.

#### 2.1.1 Features

- ◆ Compatible with IEC 60914, GBT 15381-94;
- ◆ Ultra-five wire shielded cable, 100M network full-digital audio and control signal transmission, sound quality is not affected in long distance transmission;
- ◆ Built-in high-performance CPU, set the translation, discuss, sign, vote, electronic nameplate as a whole, be capable of high-speed voting, vote, information transmission, can support for the 4000 meeting units to the maximum;
- ◆ can simultaneously open 8 mic, 15 +1 channels simultaneous interpretation;
- ◆ 32-bit high speed DSP floating-point processing, acoustic feedback suppression, echo cancellation, noise cancellation, digital equalizer, all to provide a perfect sound quality of high sensitivity ;
- ◆ Support PC management software, TCP/IP control, provide reliable control and safety management
- ◆ Support a variety of camera control

protocols of PELCO-D, VISCA, SAMSUNG, and CREATOR. With the CREATOR matrix or control, it is capable of automatic camera tracking.

- ◆ PC software unified management unit and intelligent fault analysis, can analyze the meeting unit type, quantity, distribution, fault etc.
- ◆ Hot backup, the system can normally operate even though one of the controllers broken down. The meeting will not be interrupted, instead, it can continue speech, vote and voting.
- ◆ With RCA, phoenix head, XLR head three different audio input interface, support the balanced and unbalanced input, support 4 audio mixer input or 3 audio mixer input and 1 remote video conference input.
- ◆ With RCA, phoenix head, XLR head three different audio output interface, support the balanced and unbalanced output, support the conference unit partition, support 4 speaker partition output, can effectively improve the microphone gain instead of howling, you can configure any Output interface to connect to the remote video conference system.;
- ◆ Can individually adjust line, remote video conferencing input, 4 audio output interface, the conference unit volume size, the adjusting range is mute, 40dB to 0dB.

inch cabinet;

Step three, fix it with a screw. As below:

## 2.1.2 host installation

full digital conference host uses all metal chassis, can be placed together with a variety of devices. In addition, fully digital conference host can also be mounted on a standard 19 inch cabinet, steps are as follows:

Step one, first fix the hanging ear on the chassis with the screw;

Step two, put the chassis on the standard 19

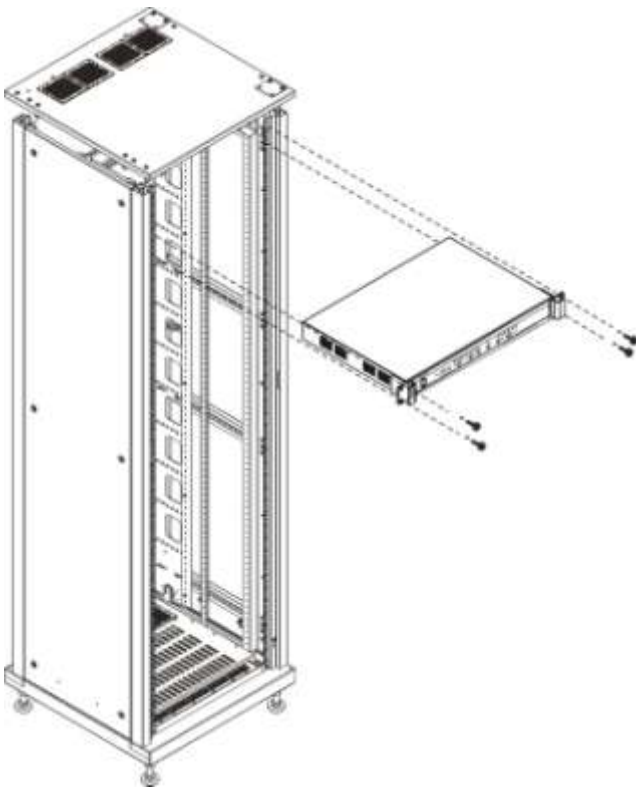

### 2.1.3 panel description

CR-DIG5201-A front panel:

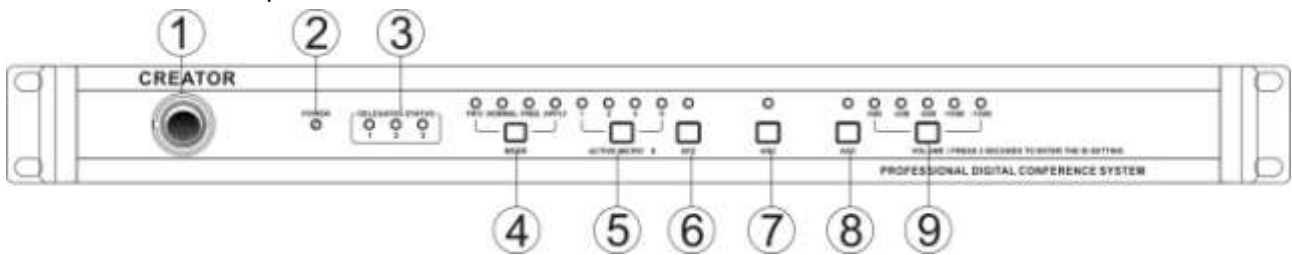

CR-DIG5201-A rear panel:

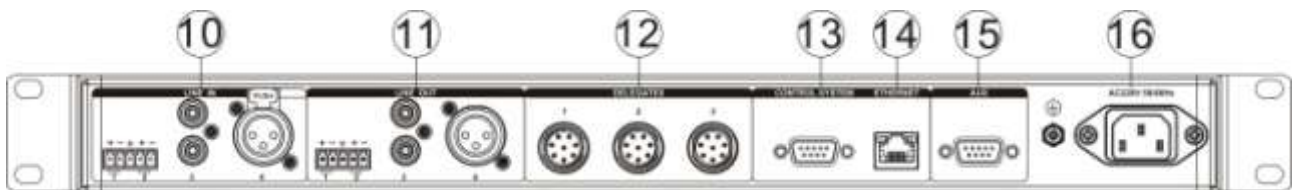

### ① The host power switch

### ② POWER—host power indicator

If the system host is normally power, this indicator light up

### ③ DELEGATES STATUS—conference unit communication indicator

Communication lamp, corresponding to the rear panel interface of the conference unit, when there is a conference unit connect to a meeting unit interface, the corresponding indicator lights flashing.

### ④ MODE—mode setting

◆ **FIFO mod**, Once the maximum number of speakers is reached, the first opened microphone will be switched off by the newly pop-up representative units.

◆ **NORMAL mode**, If the limit of maximum number of speakers is reached and other representatives want to speak, Automatically enter the waiting queue, the number of representatives waiting in the queue corresponds with the maximum number of speakers set in the system.

◆ **FREE mode**, Allow six representatives to speak, no wait.

◆ **APPLY mode**, The representative unit should obtain the approval from the Chairman or operator before speaking. The waiting number should be equal with the maximum number of speakers. Signing attendance and voting will shut down the microphone of representative units or make it wait for clear.

### ⑤ ACTIVE MICRO'S—the maximum speech settings

### ⑥ AFC—The noise suppression control keys,

adjust DSP1 channel

⑦ **ANC**—Noise suppression button, adjust DSP1 channel.

⑧ **AGC**—Microphone automatic gain control keys, adjust DSP1 channel.

### ⑨ VOLUME—output volume control button and ID setting

Adjust output volume, the adjust range of 0dB~-15dB, software adjust range can reach to 0dB~40dB, MUTE.



**Long press the "VOLUME" button for 3s to enter the set ID status. and then long press "VOLUME" button for 3s to exit set ID status. long press "volume" and "mode" at the same time to restore the default factory settings. the default IP address is : 192.168.10.100, port: 10166.**

### ⑩ LINE IN

Line In, input 2, can connect to a remote video conference, and telephone terminal output. Through the menu software can adjust "sound frequency Settings" - "volume control" - "line in", can set the input audio for volume 2, select "speaker partition Settings" - "output" video conference, input 2 audio will not sent to the corresponding line out.

Line In, input 1, cannon head interface input 4, RCA interface input 3, connect the background music etc, input 1, cannon head input 4, RCA input three-way audio mixing through the menu software adjust "audio Settings", "volume control", "line", can set the mixing volume, and audio output will remain out of the line.

Line In, Phoenix head interface and cannon head interface can support balance and unbalance input.

## 11 LINE OUT

Audio output interface, Connected to the amplification system, enlarge the speaker voice output, or connect to the recording device for recording.

Through the menu software, close the speaker part, output 1、output2, cannon output 3, RCA interface output 4.

Speaker partition function can be open。Output 1 for OUT1, output 2 for OUT2, RCA output 3 for OUT3, cannon head output 4 for OUT4.

Microphone audio can through, "audio Settings" -- - "line out", adjust the volume. When the open speaker the partition function, can adjust the partition gain, each partition the microphone to the amplifier gain can be adjusted separately.

## 12 DELEGATES——conference unit interface

Provide 3 road connect port, can connect speech unit or translation unit and the connection box.

## 13 CONTROL SYSTEM

Can connect to central control host ,camera tracking host or directly connect to camera,can reach auto tracking function.When the camera is used to directly control the RS485 interface, must enlarge RS232 to RS485 equipment.

## 14 ETHERNET

Provide 1 road Ethernet connection port, can connect to computer to implement the software management.

## 15 AUX——RS-232 port.

When the conference host directly connect to the camera,this interface can connect the CREATOR matrix product, implement multiple camera video input.

## 16 System power input port

The host power input, support AC110V/220V.

## 2.1.4 Descriptions of the ports

### 2.1.4.1 CONTROL SYSTEM——RS-232

Full digital conference system can use a variety of control systems via RS-232 serial interface.。

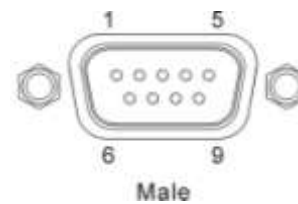

COM port pin is described as follows:

pin	Signal	description
1	-	Null
2	RXD	Receiving data
3	TXD	sending data
4	-	Null
5	GND	GND
6	-	Null
7	-	Null
8	-	Null
9	-	Null

## AUX——RS-232

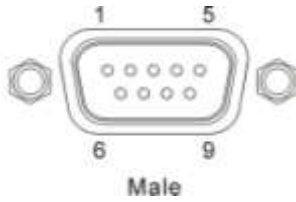

Wh ite gre en	gre en	Wh ite ora nge	blu e	Wh ite blu e	ora nge	Wh ite bro wn	bro wn
------------------------	-----------	-------------------------	----------	-----------------------	------------	------------------------	-----------

COM port pin is described as follows:

pin	signal	description
1	-	Null
2	RXD	Receiving data
3	TXD	Sending data
4	-	Null
5	GND	GND
6	-	Null
7	-	Null
8	-	Null
9	-	Null

T568B linear order							
1	2	3	4	5	6	7	8
Wh ite ora nge	ora nge	Wh ite gre en	blu e	Wh ite blu e	gre en	Wh ite bro wn	bro wn

### 2.1.4.2 Production methods of ETHERNET RJ45 cable

The system uses shield five line as the wire, and install RJ45connector (commonly known as crystal head) at the CAT5 ends, and connect the equipment with straight line access network. The standard connection of twisted pair is not arbitrary, it is to ensure the symmetry of cable connector layout, thus to offset the interference between the cables in connector. Super five lines generally have four pairs of twisted thin line, which are marked with different colors.

Twisted pair there are two kinds of connection: EIA / TIA 568B standard and EIA / TIA 568A standard

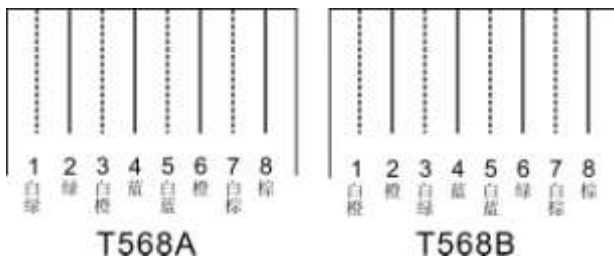

Direct line: both ends are connected by T568B line sequential standard.

Cross-line: one end is connected by T568A line sequential standard, the other is connected by T568B line sequential standard.



**When connected to the network router, it uses the straight line connection. When connected to a PC computer control, it uses crossover cable connection.**

### 2.1.5 Menu Software Illustration

The full digital conference system can be managed easily with the “Digital Conference Menu” software.



T568A linear order							
1	2	3	4	5	6	7	8
1	2	3	4	5	6	7	8

### 2.1.5.1 MENU Options Illustration

MENU options include “Connection”, “Mainframe”, “Units Management”, “WIFI management”, “Language”, and “Exit” etc.

#### 2.1.5.1.1 “Connection” Options Illustration

The “Connection” item includes “Connection Settings” and “Automatic IP address checking”.

The “Connection Settings” mainly configures the mainframe’s IP address and port number. .

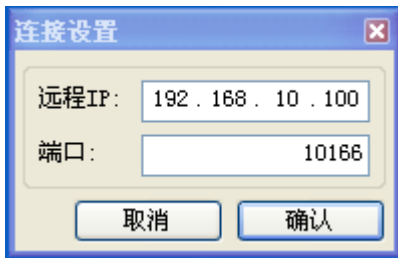

The “Automatic IP address checking” can automatically recognize the mainframe’s IP address.

#### 2.1.5.1.2 “Conference System Mainframe” Options Illustration

“Conference System Mainframe” option includes: “Network Settings”, “MAC Address Settings”, “Temperature Control Settings”, “Restore Factory Settings”, etc.

“The “Network Settings” can change the mainframe’s IP address, Mask, and Gate, etc.

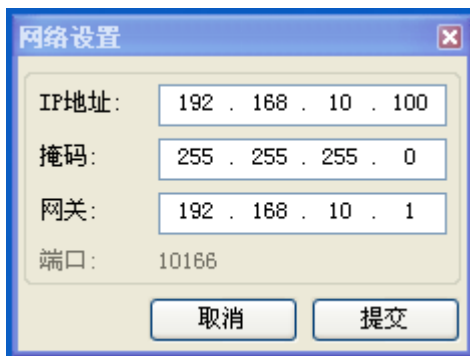

The “MAC Address” can change the mainframe’s MAC address. When there are more than one piece mainframes are in the same LAN, we have to set the MAC addresses.

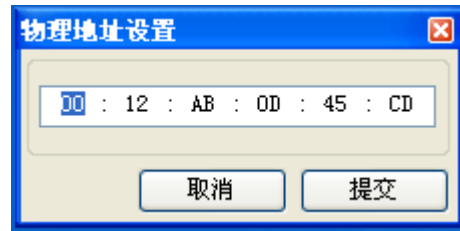

The “Temperature Control Settings” can change the mainframe’s threshold temperature value. When the current temperature reaches this value, the cooling fan will be turned on automatically.

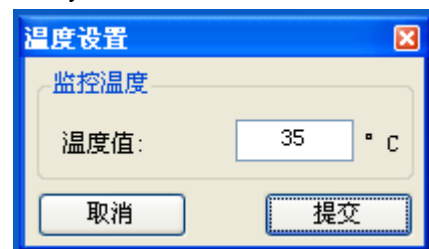

The “Restore Factory Settings” can restore all settings to default factory values.

#### 2.1.5.1.3 “Unit Management” Options Illustration

Unit Management” includes “Unit Scan” and “Unit ID Settings”.

Select “Unit Scan” to display the system’s units’ status, including the quantity, chairman units’ quantity, delegate units’ quantity, and the translator consoles’ quantity.

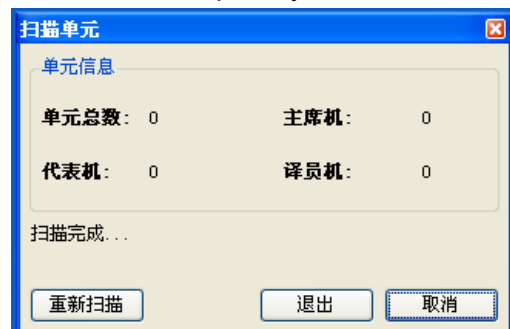

“Unit ID Settings”





◆ The units ID settings are allocating one unique address for each unit in the system for the mainframe to recognize the units.

◆ How to set the ID

After the conference system is connected, turn on the mainframe, and select: "Unit Management" "Start allocating ID".At the same time, all units and the translator consoles will display as following:



Translator consoles display as following

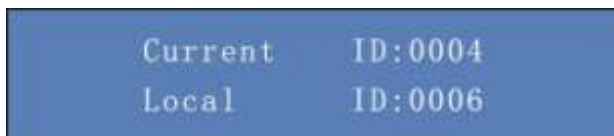

Now the user need to press the unit microphone's button to set their ID one by one. The unit microphone indicator will flash for one time or keep on, which means the current ID is unique. If the unit microphone indicator flash for a few times and keep on, it means there are at least two devices having the same ID. After the ID settings are done, the units' microphone indicators will keep on. Flashing indicator means the ID settings are not successful. After successfully set all units' ID, press "Stop ID Settings" to exit ID settings procedures. If there are different units having the same ID, the ID settings should be performed again. The mainframe display will also show the relevant

information.

When the mainframe is powered on again, it will also automatically detect whether are the duplicating IDs. .

#### 2.1.5.1.4 "language"option instructions

Configures the conference system units' language. Both English and Simplified Chinese are supported

#### 2.1.5.1.5 "exit"option instruction

Click"exit"to close software

### 2.1.5.2 Connection and read configuration instructions

When the host IP is complete,click "built connection"t to connect with the host,at this point,can set the parameters for the host.when need to disconnect,click the "disconnect".

When click"read configuration" , The software will get the host configuration parameters, realize the host and synchronization software parameters.

### 2.1.5.3 "Meetings Management"

#### 2.1.5.3.1 Microphone mode



##### 1、 FIFO mode

When the system reaches the maximal active microphone quantity, the earliest opened microphone will be turned off by the latest turned on microphone. .

##### 2、 NORMAL mode

When the system reaches the maximal active microphone quantity, the extra applying microphones will enter the waiting queue automatically. The waiting queue microphone quantity is the same as the set maximal active microphone quantity.

### 3、 FREE mode

Allow 6 active microphones, no waiting queue

### 4、 APPLY mode

The delegate units need the chairman unit's approval to speak. The waiting queue quantity is the same as set maximal active microphone quantity. Signing-in and voting will turn off the delegate microphones or clear the waiting queue.

#### 2.1.5.3.2 Mic Quantity

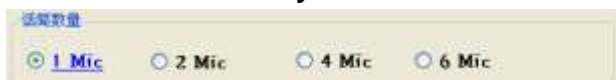

Active delegate unit quantity limitation: configures the maximal active delegate microphone quantity to be 1/2/4/6, correspondent chairman microphone quantity 7/6/4/2. The whole system can support maximally 8 active microphones.

#### 2.1.5.3.3 SYSTEM LANGUAGE



Configures the conference system units' language. Both English and Simplified Chinese are supported.

### 2.1.5.4 “Audio Settings” Configuration

#### 2.1.5.4.1 DSP AUDIO EFFECTS SETTINGS AND UNIT LOUDSPEAKER SWITCH



##### DSP Channel 1:

Configures DSP channel 1's DSP processing algorithms, support AFC, ANC, and AGC.

**DSP Channel 2:** Configures DSP channel 2's DSP processing algorithms, support AFC, ANC,

and AGC.

**Loudspeaker Settings:** "ON": the conference system units' loudspeakers will be turned on (translator consoles not included); "OFF": conference system units' loudspeakers will be turned off.

**Unit DSP Processing:** "ON": they system will automatically use DSP channel 1 to process the unit audio, including AFC, ANC, and AGC. When it's on, as shown in the following image, the "DSP Channel 1" will change to "Unit DSP Channel":

The system supports 2 ways audio DSP processing.

#### 2.1.5.4.2 Volume



**Line IN:** adjusts the line in volume, corresponding to the mainframe's Line In 1, Line In 3, Line In 4 inputs;

**Line OUT:** adjusts all microphone audio line out volume;

**UNIT Line OUT:** adjusts the microphones' original sound volume;

**Video Conference System Line IN:** adjusts video conference system line in volume, corresponding to the mainframe's Line In 2 input;

**Treble:** adjusts all microphones' treble. If the menu software "Audio Settings" –"Sound Field Selection" is "Original Sound", this adjustment is invalid.

**Bass:** adjust all the microphone audio bass, when the software menu "Audio Settings" - "sound field choice" choose "the original tone", the adjustment was invalid.

#### 2.1.5.4.3 Sound Field Selection



#### Sound Field Selection:

The system supports POP, SOFT, BASS, CLASSIC, OLD, ORIGINAL, CUSTOME, etc. sound effects. When "CUSTOME" is selected, we can enter the settings page for the gain of each bands. The value range is -20dB ~ +20dB, totally 7 bands equalization, which are 100Hz, 215Hz, 460Hz, 1KHz, 2.2KHz, 5KHz, and 11.5KHz. Click "Restore to Custom", all 7 bands will be restored to 0dB.

#### 2.1.5.5 Camera Settings

Camera Settings configures the presets of the camera, including protocol selection, camera mapping, and start setting three parts. First, we need to choose the camera's protocol, then set the camera's mapping relations, and finally enter and exit the settings.

#### 2.1.5.5.1 Camera Protocols



There are four protocols for choice: SAMSUNG, VISCA, PELCO\_D, and CREATOR, which is used to connect to CREATOR controller or the CR-MVC6300 HD camera auto-tracking system mainframe, while the camera mapping is invalid.

#### 2.1.5.5.2 Camera Mapping



When configuring the camera mapping, first we need to select the camera ID, the corresponding camera address and matrix channel. The "Camera Address" is the control camera's address, "Matrix Channel" is the input channel of the matrix, and the matrix's output channel is fixed to output 1. Camera ID represents one camera. Each camera corresponds to one camera address and one matrix switcher channel. There can be maximally 16 cameras and 16 matrix channels. The camera address value is adjustable from 1 to 254, while "OFF" means it hasn't been configured. Please set the mapping relations one by one.

#### 2.1.5.5.3 Start Camera Settings

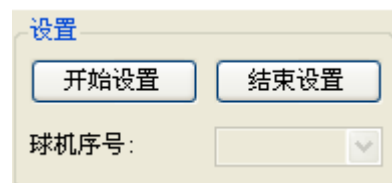

After the camera mapping is set, we start to set the camera's presets. The camera ID is the

mapping relations we mentioned above, which is adjustable. When it has been adjusted to other cameras, the matrix switcher will automatically switch the channel. Select the camera we want to configure, adjust its corresponding microphone's presets. Turn on and off the corresponding microphone can complete the ID presets. Follow the same procedures to finish the preset settings for all the units. Exiting the settings will use the current preset as the panorama view position. In order to reduce wrong operations, the system requires that there should be at least one ID preset to make sure exiting settings will create a panorama view preset position. Otherwise the panorama view preset is invalid.

## 2.1.5.6 Translation Settings

### 2.1.5.6.1 Automatic Channel

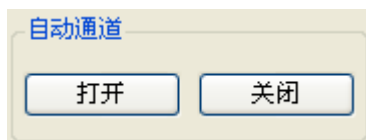

ON: if there is no translation, this channel will be the original sound; if there is translation, it will be translation output;

“OFF”: will not automatically switch to the original sound; if there is no translation, this channel will have no sound;

### 2.1.5.6.2 Total channel quantity

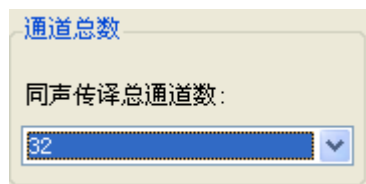

To set the total channel quantity for the translator console, maximally 32 channels;

### 2.1.5.6.3 Translation Room Quantity Settings

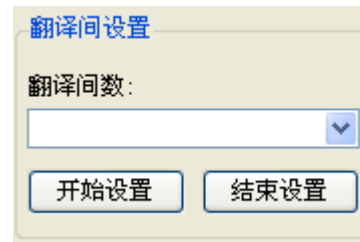

To set the translation room number. For multiple translator consoles within the same translation room: as long as one translator console microphone is active, all other translator consoles'

microphone will be turned off.

Click “Start Setting”, all translator consoles will display their current translation room number, as shown in the following image:



Turn the translator console's “SELECT OUT” knob to change the room number. After the correct value is selected, click “End Setting” to finish the translation room number settings.

### 2.1.5.6.4 Channel Lock



When “Channel Lock” is selected, all the translator consoles' “SELECT OUT” knob cannot be used to adjust the channel number to avoid wrong operations.

### 2.1.5.6.5 Channel Language



To set the language name for each translator unit.

### 2.1.5.7 Loudspeaker Zoning Settings

The system supports loudspeaker zoning function, every zone's microphones' output volume to the mainframe is adjustable.

#### 2.1.5.7.1 Loudspeaker Zoning Function Switch

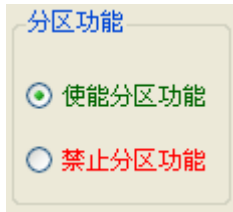

When this function is disabled, all line out volume is controlled via "Audio Settings" "Line Out". All four mainframe outputs are the same, and it is default that they will be processed using "DSP Channel 1". When it is enabled, each zone's microphones audio output the the mainframe can be adjusted independently

#### 2.1.5.7.2 Microphone Zoning



This function supports maximally 4 zones, which cannot overlap with each other. Each microphone has only one zone. The maximally ID value is 4000. In the above image, it means that ID 1~100 belong to Zone 1, 101~200 belong to Zone 2, 301 ~ 4000 belong to Zone 4.

#### 2.1.5.7.3 Loudspeaker Zoning Gain Control



#### OUT 1 Gain:

Video Conference Output: select video conference system output, the mainframe's OUT 1, which is the mainframe Line OUT phoenix interface's left sound track can connect to video

conference system terminal. The corresponding video conference terminal output audio will not go back to the input end.

**DSP Channel 1:** select “DSP Channel 1”, this OUT output is processed via “DSP Channel 1” and outputting;

**DSP Channel 2:** select “DSP Channel 2”, this OUT output is processed via “DSP Channel 2” and outputting;

**Zone 1:** Zone 1 microphones to OUT1 gain adjustment, the range is: mute, -40dB ~ 0dB;

**Zone 2:** Zone 2 microphones to OUT1 gain adjustment, the range is: mute, -40dB ~ 0dB;

**Zone 3:** Zone 3 microphones to OUT1 gain adjustment, the range is: mute, -40dB ~ 0dB;

**Zone 4:** Zone 4 microphones to OUT1 gain adjustment, the range is: mute, -40dB ~ 0dB;

#### **OUT 2 Gain:**

Similar to OUT 1 Gain;

#### **OUT 3 Gain:**

Similar to OUT1 Gain;

#### **OUT 4 Gain:**

Similar to OUT1 Gain;



**For each output interface, there can only be one DSP processing, supporting maximally 2 ways audio processing. When the “Unit DSP Processing” is on, only “DSP Channel 2” can be used.**

## **2.1.6 Double-machine hot backup**

Double-machine hot backup : consist of two conference host,to ensure that a host malfunction , can in time automatically or manually switch to the backup host, and the data will not be discarded, the meeting can be carried out as normal

#### **steps as follows:**

1、 2 host parameter set into consistent.

2、 2 host IP address, MAC address set into different

3、 2 host line out respectively connect to sound console for Mixing processing. when using 2 channel speaker partition, 2 road Line Out respectively output to the sound console.

when using 4 channel speaker partition, 4 road Line Out respectively output to the sound console.

4、 2 host output connect to active connection box,and then all conference unit connect to active connection box.



**when the active connection box connect to the host,should cut off the power supply.**

## **2.1.7 technical parameters**

parameters	CR-DIG5201-A
Power supply	110V/220V AC
Frequency response	20Hz~20kHz
Signal-to-ration(S/N)	> 80dB
Channel talkcross	> 80dB
Total harmonic	< 0.05%
Power consumption	150W
Static power	12W
Dimensions(mm)	483L x 260W x 43.6H (mm)
color	Dark gray

### 2.1.8 connection diagram

Solution1:with camera tracking host

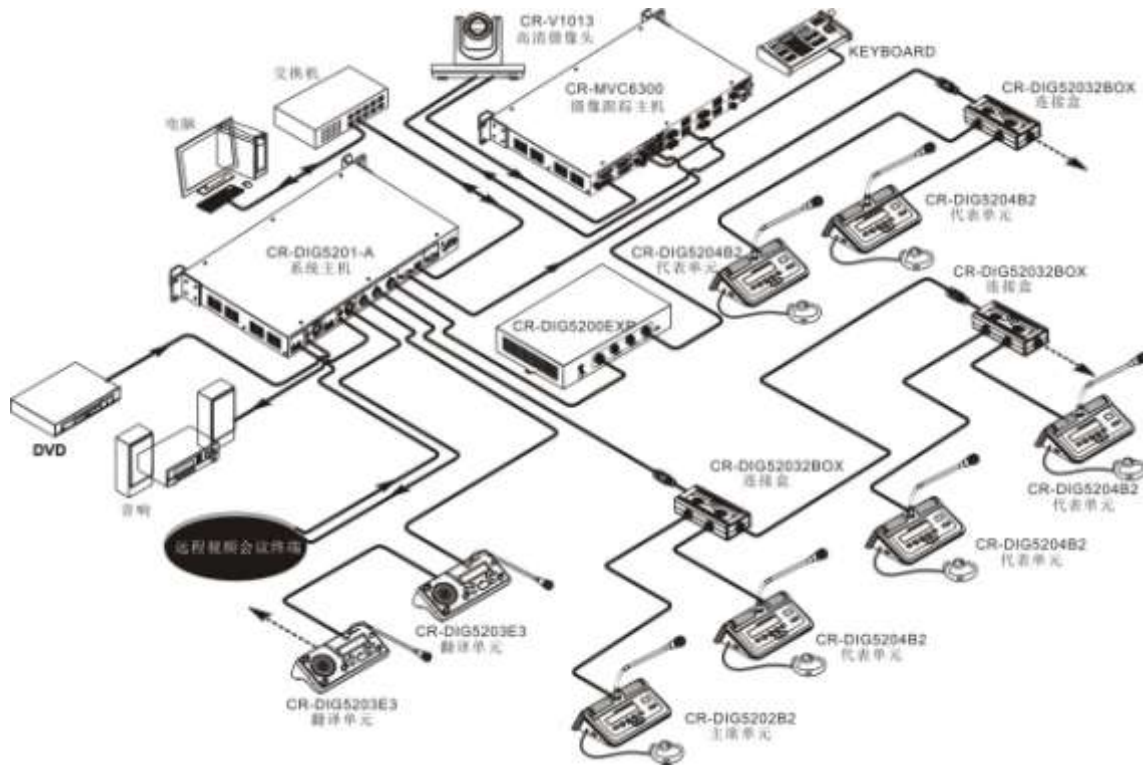

Solution 2:with matrix and camera.

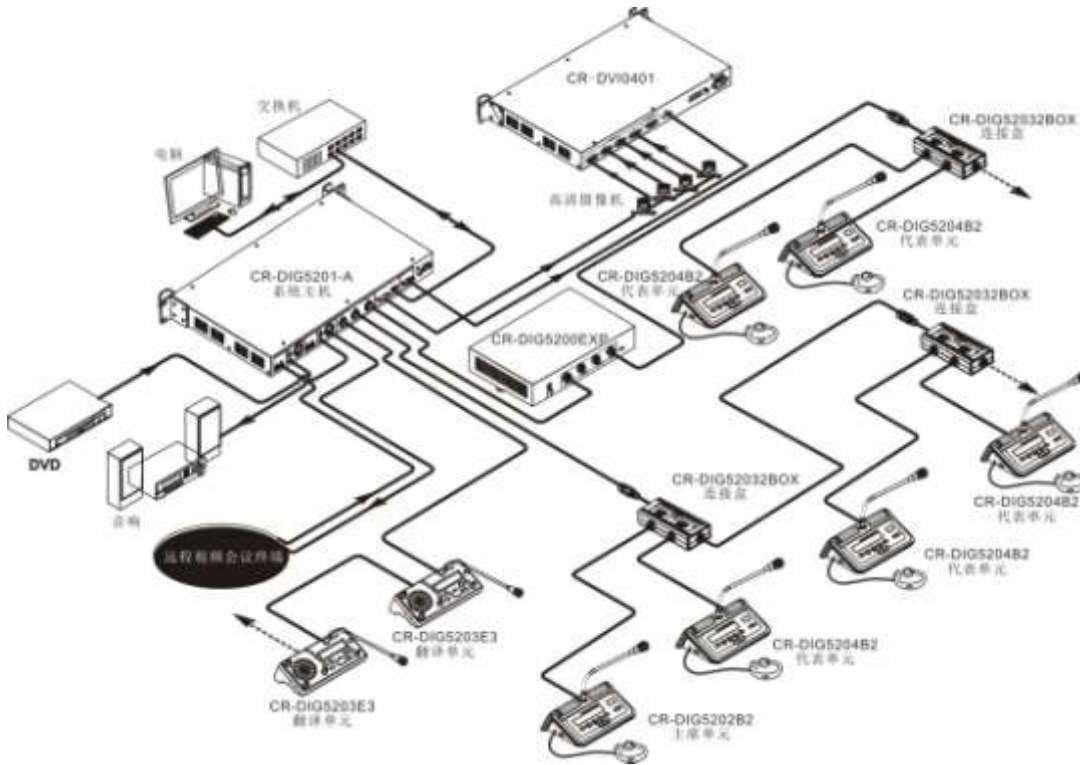



Solution 3: double-machine hot backup.

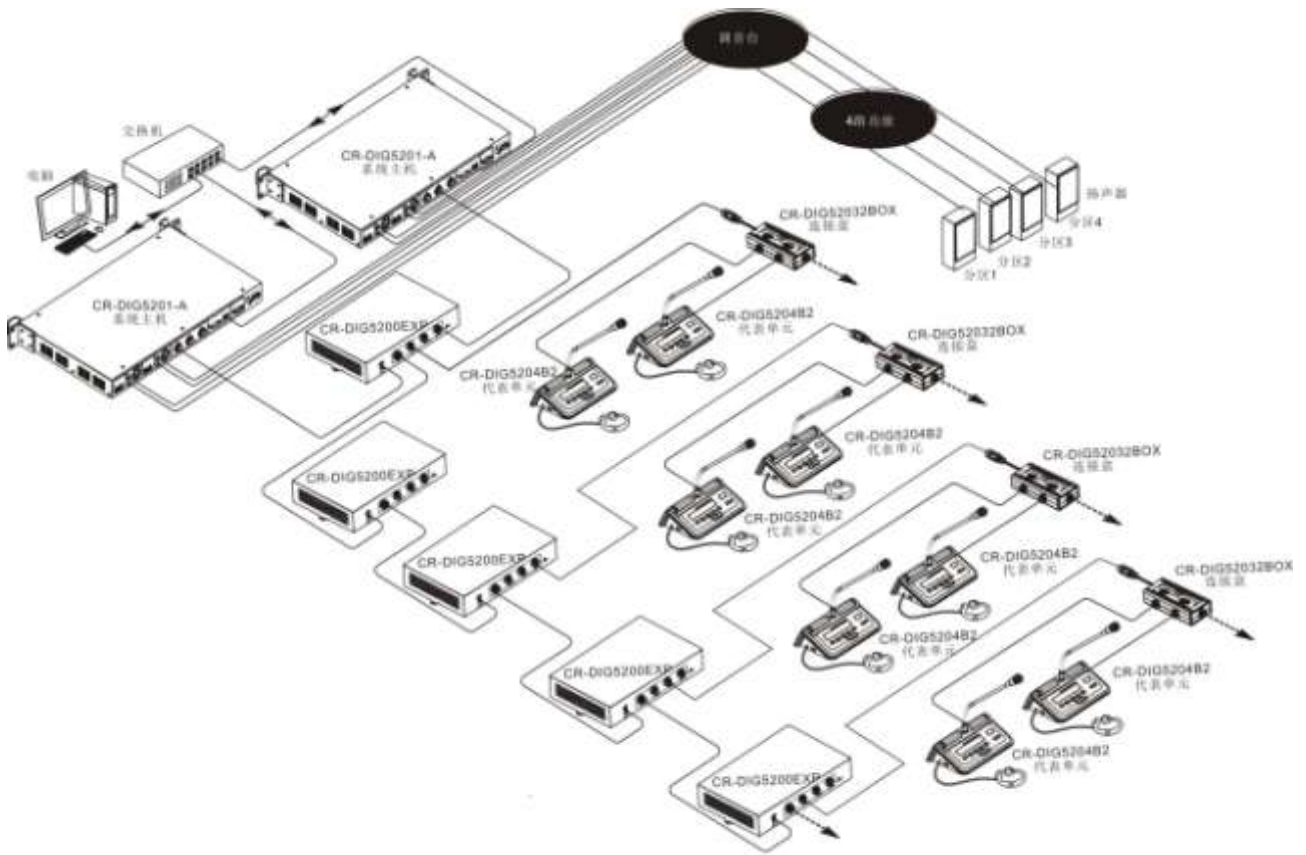

## Chapter3、 conference system unit

### 3.1 Translation unit

CR-DIG5203E3 is a fully functional translation unit, can simultaneously 31 + 1 kind of languages simultaneous translation, direct translation and indirect translation function.

#### 3.1.1 features

- ◆ full digital audio technology, in-built high-speed DSP processing;
- ◆ 20~20K perfect sound quality;
- ◆ blue 320x64 LCD screen;
- ◆ cardioid condenser pickup, with two-color indicator light, to speak in red;
- ◆ comes with 2 m connection cable;
- ◆ knob plug microphone pole;
- ◆ has a magnetic speaker, headphone jack and volume control knob;
- ◆ have indirect translation and direct translation function;
- ◆ internal calls;;
- ◆ short message;
- ◆ tea application;
- ◆ cough elimination;
- ◆ can be set to the operator;
- ◆ two sets of head-mounted microphone and headphone jack;
- ◆ speaker and headphone volume individually adjustable;
- ◆ support microphone pickup for head-mounted microphone and microphone pole;
- ◆ volume size Indicator;
- ◆ Input channel shortcut keys;
- ◆ output channel shortcuts;
- ◆ speech timing function;;
- ◆ the number of translation units is almost unlimited.;
- ◆ 31+1 simultaneous interpretation.

#### 3.1.2 panel description

Front view:

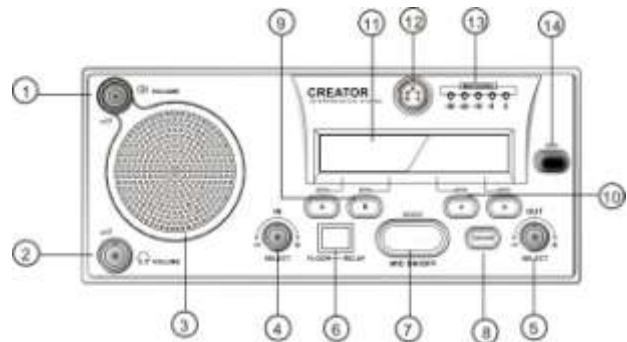

Side view:

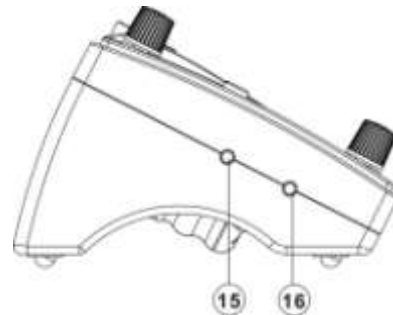

- ① speaker volume control knob.
- ② the headphones volume knob
- ③ built-in speakers.
- ④ IN - input channel selection knob.
- ⑤ OUT - Output channel selection knob
- ⑥ FLOOR-RELAY - Sounds and indirect translation switch.
- ⑦ MIC ON/OFF——microphone switch.
- ⑧ COUGH - cough elimination button. Press and hold in translation status, a temporary interruption to prevent cough being passed, release to return to normal translation.
- ⑨ A, B –input channel shortcuts. Select an input channel and press A or B button for 3 seconds,the button becomes the channel shortcut key, you can quickly select input channel.
- ⑩ a, b, - output channel shortcuts. Select

an output channel, long press a or b for 3 seconds,the button becomes the shortcut key, you can quickly select output channel.

⑪ LCD display - Resolution 320X64, the left shows the input channel number and multilingual information. The right displays output channel number and multilingual information.

⑫ Microphone jack.

⑬ Microphone/microphone volume indicator -microphone volume indicator indicates The volume level of current speech, with or without translation voice.

⑭ CALL—multi-function button. Long press this,button to enter setup mode interface. You can set the corresponding relations of languages and channels, switch . on electricity and press the button long for the switch of operator and translation unit.

⑮ Microphone jack.

⑯ Headphone jack.

### 3.1.3 Descriptions of panel display

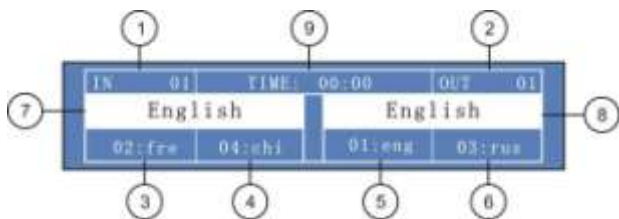

- ① input channel indication.
  - ② output channel instructions.
  - ③ the channel and multilingual instructions corresponding to input channel shortcut key A. .
  - ④ the channel and multilingual instructions corresponding to input channel shortcut key B. .
  - ⑤ the channel and multilingual instructions corresponding to output channel shortcut key a. .
  - ⑥ the channel and multilingual instructions
- When internal calls applies, the operator translation unit LCD display shows as below corresponding to output channel shortcut key b
- ⑦ input channels languages.

⑧ output channels languages.

⑨ speech timing,maximum timing for 99 minutes 59 seconds

**Services:** In the conference mode, press the number key"CALL" button to enter the service menu, which can offer language switch, intercom, tea applications and viewing the short message.



Press "A" key, enter internal call.

Press "B" key to enter the tea applications.

Press "a" key to view short messages.

Press "b" key to return to the previous menu. .

### 3.1.4 operator

Translation unit can be set to the operator unit,for the convenience of intercom Microphone jack.management. Translation unit is set to operator as follows:

Before power translation unit, press and hold the translation unit "CALL" button, release the button until operator set, translation unit is set to operator.The operator can be set to translation unit in the same way.

Operator is usually installed in management room to monitor conference translation channels, true voice, the whole hall intercom.

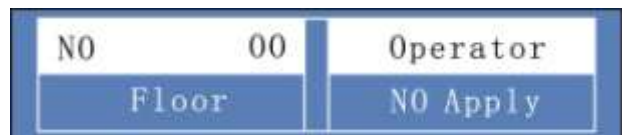

When internal calls applies, the operator translation unit LCD display shows as below



Press "Agree" button, the call begins, the LCD display shows as below:



Press "EXit" button to finish the call and quit,

### 3.1.5 technical parameters

Parameter	CR-DIG5203E3
Power supply	The host power or DC24V input
Frequency Response	20~20KHz
Signal-to-noise ratio (S/N)	> 80dB
Channel cross talk	> 80dB
Total harmonic distortion	< 0.05%
Power consumption	1.8W
Microphone parameters	Condenser cardioid

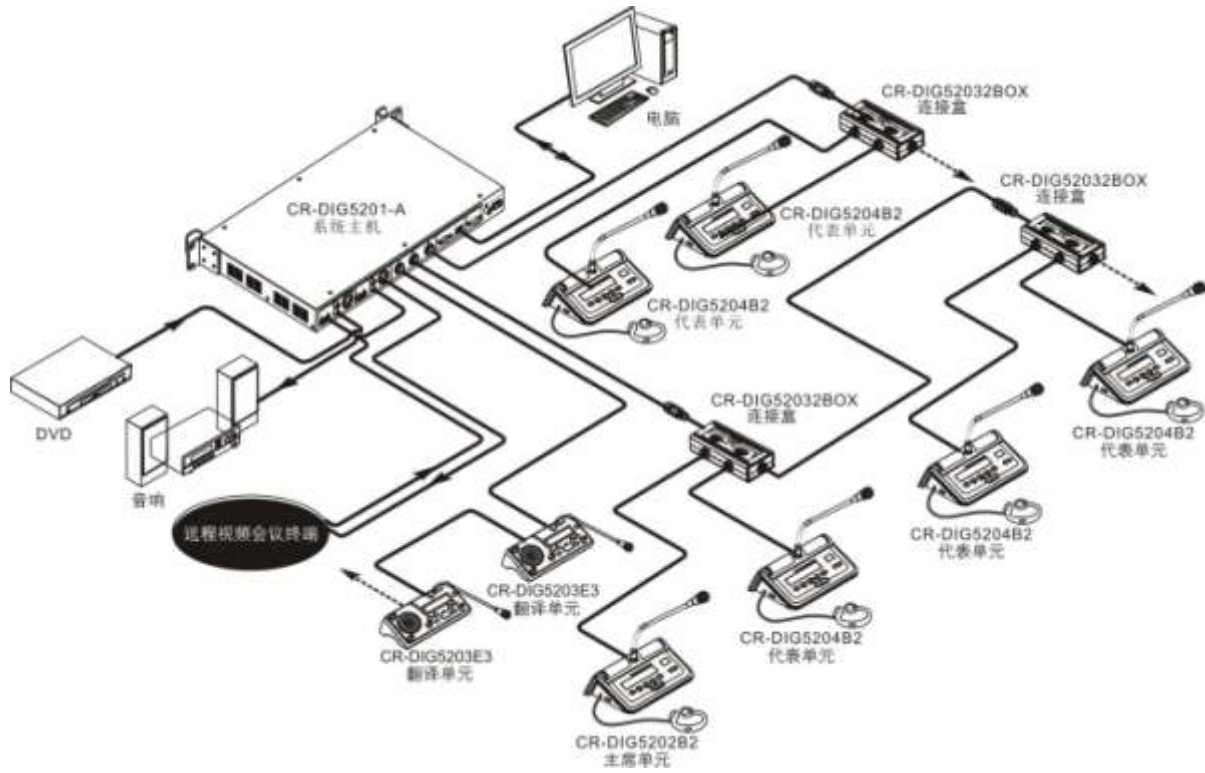

microphone core type	unidirectional
Sensitivity	-46 dBV/pa
Frequency response	20~20KHZ
Input impedance	
Speaker	2W
Headphone output	> 8
Headphone loads	10mW
Headphone volume	
display	320X64lattice (blue white)
Unit interface	8 core aerial head
Dimensions (mm)	290LX128WX86.6H
color	Dark gray

### 3.1.6 System connection diagram





### 3.2 product classification



Appearance	model	Product features
	Hands free mic LCD speaking and voting unit: CR-DIG5202A2 chairman speech unit CR-DIG5204A2 delegate speech unit	desktop The built-in microphone Built-in speaker High sensitivity Speak,vote,31+1 channel selection 320*64 LCD interface 320*64 LCD name display
	VFD speaking and voting unit : CR-DIG5202B2 chairman speech unit CR-DIG5204B2 delegate unit	desktop The built-in microphone Built speaker vote 31+1Channel selection 320*64 LCD LCD interface 256*64 VFD name display
	Desktop pure speech unit: CR-DIG5202E1 pure speech chairman unit	desktop No speaker No channel selection No name display Pure speech

		
	<p>Desktop speaking and voting unit:                  CR-DIG5202E2 chairman speech unit                  CR-DIG5204E2 delegate speech unit</p> <p>With simultaneous interpretation speaking and voting unit                  CR-DIG5202E3 chairman speaking and voting unit                  CR-DIG5204E3 delegate speaking and voting unit.</p>	<p>Desktop                  No speaker                  speech                  Vote                  No channel selection                  160*20LCD interface                  No name display</p>

	<p>Simple type speaking and voting unit:  CR-DIG5202D2 chairman unit  CR-DIG5204D2 delegate unit</p>	<p>desktop  No speaker  speech  vote  No channel selection  160*20LCD interface  No name display</p>
	<p>Embedded unit:  CR-DIG5202C1 chairman speech unit  CR-DIG5204C1 delegate speech unit</p>	<p>Embedded installation  No speaker  Speech  No vote  No channel selection  No LCD interface  No name display  Touch buttons  Can be combine with any embedded unit of this series</p>
	<p>Embedded unit:  CR-DIG5202C2 chairman unit  CR-DIG5204C2 delegate unit</p>	<p>Embedded installation  No speaker  vote  No speech  No channel selection  No LCD interface  No name display  Touch buttons  Can be combine with any embedded unit of this series</p>
	<p>Embedded unit:  CR-DIG5206CH channel selection unit</p>	<p>Embedded installation  No speaker、no speech、no vote、no name display、no LCD interface  31+1channel selection  Touch buttons  Can be combine with any embedded unit of this series</p>



	<p>Embedded II generation unit:                  CR-DIG5202C1-S chairman unit                  CR-DIG5204C1-S delegate unit</p>	<p>Embedded installation                  No speaker                  speech                  No vote                  No channel selection                  No LCD interface                  No name display                  Touch buttons                  Can be combine with any                  embedded unit of this                  series</p>
	<p>Embedded II generation unit:                  CR-DIG5202C2-S chairman unit                  CR-DIG5204C2-S delegate unit</p>	<p>Embedded installation                  No speaker                  No speech                  vote                  No channel selection                  320*64LCDinterface                  No name display                  Touch buttons                  Can be combine with any                  embedded unit of this                  series.</p>
	<p>Embedded II generation unit:                  CR-DIG5206CH-Schannel                  selection unit</p>	<p>Embedded installation                  No speaker、no speech、                  no vote、no LCD interface                  31+1 channel selection                  Touch buttons.                  Can be combine with any                  embedded unit of this</p>

		series
	<p>Embedded II generation unit: CR-DIG5202C1-C chairman unit CR-DIG5204C1-C delegate unit</p>	<p>Embedded installation No speaker No speech No vote No channel selection No LCD interface No name display button Can combine with any embedded unit of this series</p>
	<p>Embedded II generation unit: CR-DIG5202C2-C chairman unit CR-DIG5204C2-C delegate unit</p>	<p>Embedded installation No speaker No speech vote No channel selection 320*64LCD interface No name display button Can combine with any embedded unit of this series</p>
	<p>Embedded II generation unit: CR-DIG5206CH-C channel selection unit</p>	<p>Embedded installation No speaker、no speech、 no vote、no display、no LCD interface 31+1 channel selection button Can combine with any</p>

		embedded unit of this series
	Embedded II generation unit: CR-DIG5207SP speaker	Embedded installation speaker No speech No vote No channel selection No LCD interface No name display Can combine with any embedded unit of this series
	VFD display unit: CR-DIG5205DS enhance edition CR-DIG5205DS-S simple edition	desktop No speaker No speech No vote No channel selection 320*64LCDinterface 256*64 name display Touch buttons Can combine with any embedded unit of this series

### 3.2.1 CR-DIG5202/4A2 speech unit

CR-DIG5202/4A2 speech unit is a multi-function integrated hands-free microphone LCDspeaking and voting unit. it sets discussions, sign, vote, table display, simultaneous, interpretation into one. The built-in high fidelity speaker is to meet the needs of small venue PA.

#### 3.2.1.1 Features

◆ Name displayer, 320X64 LCD for identity information display, support the name, posts scroll off display or a separate display. Support text adaptive amplification, to provide the best visual effects,support 8 characters, 16 letters of the alphabet,Russian and Japanese languages in the maximum

- ◆ support all electronic nameplates of the entire,system scroll off display synchronically;
- ◆ resolve uncommon word display problems of Chinese characters;
- ◆ Support PC software or insert IC card electronic nameplate display;
- ◆ high bandwidth to transmit information, the PC software can complete about 1000 unit electronic nameplate display content delivery in one second;
- ◆ Built-in high sensitivity microphone;
- ◆ support contactless IC card sign and automatically obtain representation;;
- ◆ support 31+1 simultaneous interpretation;
- ◆ supports three vote ways:
  - A) vote: in favor of / abstain / against
  - B) the manner of election / survey

method: 1/2/3/4/5;

C) responds / Review Mode: --/0/+/++;

◆ Chairman unit has priority to shut down the speaking unit;

◆ Chairman Unit has the function of initiating vote, and ending the voting;

◆ Chairman unit can initiate three key vote (support/abstain/against) , and ending the voting;

◆ 320X64screen displays microphone number,sign results, voting results clearly;;

◆ provide tea application, short message viewing,short message indicating sound,intercom and other services;

◆ Support Chinese and English.

**3.2.1.2 panel description**

CR-DIG5202/4A2 side view:

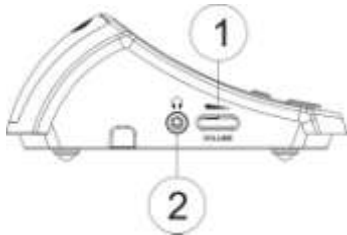

CR-DIG5202/4A2 side view:

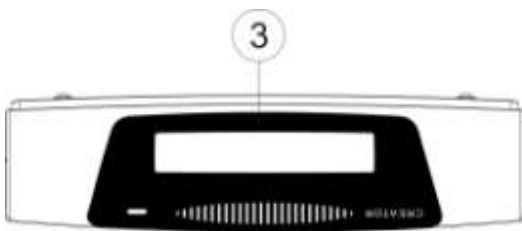

CR-DIG5202/4A2 side view:

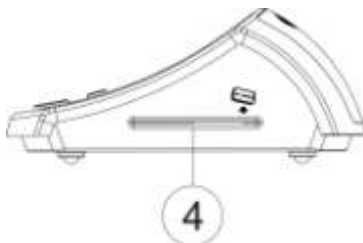

CR-DIG5204A2front view:

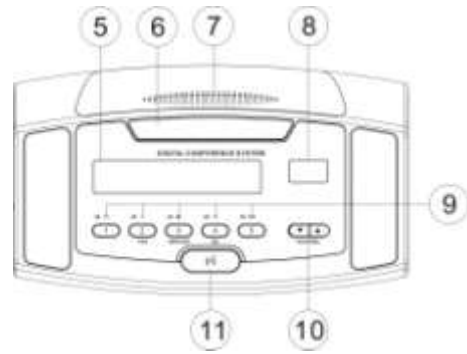

- ① volume control knob.
- ② Headphone jack.
- ③ The LCD screen (320\*64). Support 8Chinese characters . And 16 English Letters in the maximum
- ④ IC card slot.
- ⑤ 320x64 LCD display,can display operating information.
- ⑥ flat-panel microphone
- ⑦ vent. Do not place hands on top of it when you are speaking.
- ⑧ channel selection display (support for display 00-15).
- ⑨ Multi functional vote button:
  - Meeting voting,numbers 2,3,4, respectively stands for in favor of, waiver, opposed.
  - The Conference election, numbers 1-5 keys on behalf of different candidates.
  - Conference rating numbers 1-5 keys represent levels of -, -, 0, +, ++.
- ⑩ Channel selection button
- ⑪ microphone switch, Chairman' priority switch.
  - Long press the chairman unit microphone key for three seconds, close all open microphones of delegate speech unit.

**3.2.1.3 technical parameters**

parameters	CR-DIG5202/04A2
Power supply	The host power
Frequency Response	20Hz-20KHz
Channel crosstalk	>80dB

Signal-to-noise ratio (S/N)	>80dB
Mic parameters Mic core type sensitivity Frequency response Input impedance	Condenser cardioid unidirectional -46dBV/pa  20-20KHz  2.2K
Speaker	2W
Headphone output Headphone load Headphone volume	>8  10mW
display Control diaplay Name display	320X64lattice( blue white )  320X64lattice( blue white )
Total harmonic	<0.05%
Maximum power	2.2W
Unit interface	8 core aerial head
Dimensions (mm)	255.7LX156.3WX67.3H
color	silver

### 3.2.2 CR-DIG5202/4B2 speech unit

CR-DIG5202/4B2 speech Unit sets discussions,sign,vote,table display,simultaneous interpretation and other functions.into one, the built-in high fidelity cylindrical.speakers can meet needs of the venue PA.

#### 3.2.2.1 Features

◆ Name displayer,256X64VFD, used for identity information display, support name,posts scroll off display or a separate display,support

adaptive zoom,red text and whitecharacter to provide the best visual effect,support 8 characters, 16 letters of the alphabet, Russian and Japanese languages at the maximum.

- ◆ support all electronic nameplates of the entire system to scroll off synchronically;
- ◆ resolve uncommon word display problems of Chinese characters;
- ◆ Support PC software or insert IC card electronic nameplate display;
- ◆ high bandwidth to transmit information, the PC software can complete about 1000 unit electronic nameplate display content delivery in one second;
- ◆ Built-in high sensitivity microphone;
- ◆ support contactless IC card sign and automatically obtain representation;
- A) vote: support/ abstain / against
- B) the manner of election / survey method:1/2/3/4/5
- C) responds / Review Mode: --/0 / + / +;
- ◆ Chairman unit has priority to shut down the speaking unit;
- ◆ Chairman Unit has the function of initiating vote, and ending the voting;
- ◆ Chairman unit can initiate three key vote (support / abstain / against) to end vote;
- ◆ sign results, voting results clearly
- ◆ provide coffee application,short message、viewing,short message indicating sound,intercom and other services;
- ◆ Support Chinese and English.

#### 3.2.2.2 panel description

CR-DIG5202/4B2 side view:

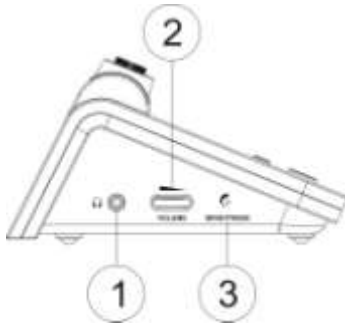

CR-DIG5202/4B2 side view:

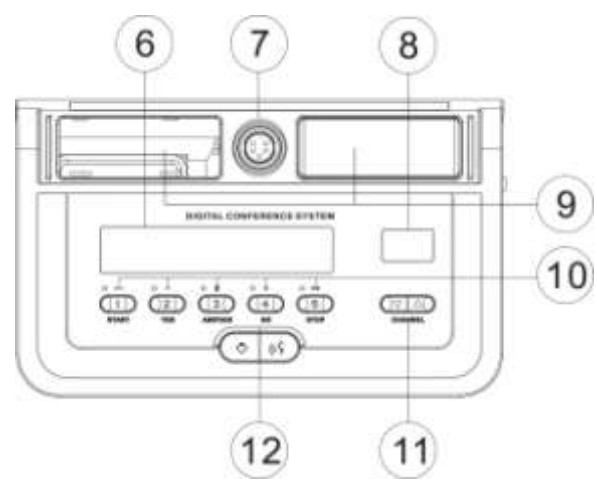
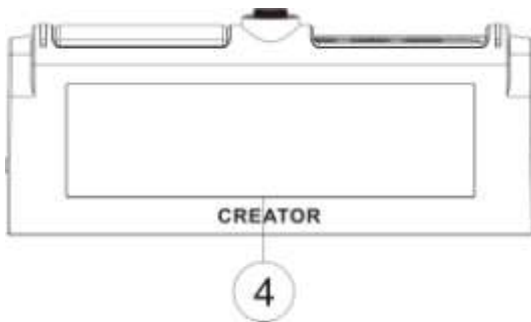

CR-DIG5204B2 front view:

CR-DIG5202/4B2 side view:

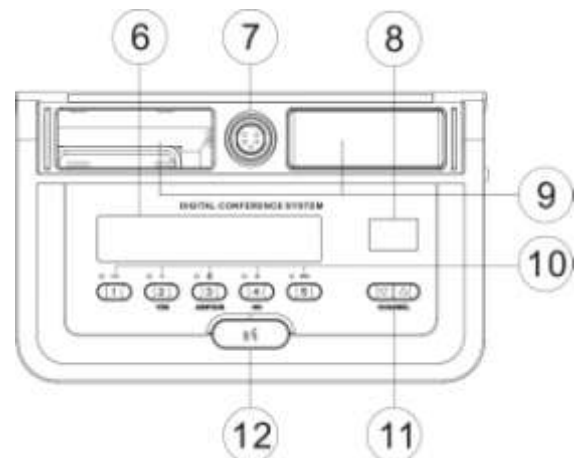

CR-DIG5202B2 front view:

- ① Headphone jack.
- ② Volume control knob.
- ③ VFD display brightness adjustment, adjusting to the "MIN" direction gets darker, adjusting to "MAX" direction gets brighter.
- ④ 256x64 The 256x64 dot matrix display can display names, titles and other information
- ⑤ IC card slot—insert IC card, read information, and be displayed on VFD screen,

thus play IC card sign function at the ⑥same time.。

⑥ The 320x64 LCD display, can display operating information

⑦ Mic jack.

⑧ channel selection display ( 00-31 ) , the channel is determined by the host setting

⑨ speaker

⑩ Multi-function vote button

——Meeting voting, numbers 2,3,4, respectively stands for in favor of, waiver, opposed.

——The Conference election,numbers 1-5 keys on behalf of different candidates.。

——Conference rating, numbers 1-5 keys represent levels of, -, -, 0, +, ++.

⑪ channel selection button.。

⑫ Microphone button priority key

Long press the chairman unit microphone

Key for three seconds,close all opened delegate speech unit.

**3.2.2.3 technical parameters**

parameters	CR-DIG5202/04B2
Power supply	DC 24V input
Frequency Response	20Hz~20KHz
Signal-to-noise ratio (S/N)	> 80dB
Channel Crosstalk	> 80dB
Total harmonic	<0.05%
Maximum power	7W
Microphone parameters microphone core type	Condenser cardioid unidirectional -46dBV/pa 20Hz~20KHz
Sensitivity Frequency Response input impedance	2.2K
speaker	2W

Headphone output	
Headphone load	> 8
Headphone volume	10mW
display	
Display control	320X64lattice (blue white) 320X64lattice (blue white)
Name display	
Unit interface	8 core aerial head
Dimensions (mm)	230.8LX160.1WX69.4H
color	Dark gray

**3.2.3 Desktop speech unit**

CR-DIG5202/04E1 is a full digital conference system desktop pure speech units

CR-DIG5202/04E2 is a full digital conference system desktop speaking and voting units

CR-DIG5202/04E3 is a full digital conference system desktop with simultaneous interpretation spokesman voting unit.

**3.2.3.1 Features**

- ◆ Chairman unit has priority to shut down the speaking unit.
- ◆ Chairman Unit has the function of initiating vote, and ending the voting;
- ◆ Chairman unit can initiate three key vote (support/abstain/against) to end vote;
- ◆ 160X20 dot matrix displays sign results, voting, results;
- ◆ Support English display
- ◆ supports three vote ways:;
- ◆ supports three vote ways
  - a)method of voting: support/abstain/against
  - b) the manner of election : 1/2/3/4/5
  - c) responds / Review Mode: --、-、0、+、++

- ◆ Support sign in;
- ◆ Support 31+1channel simultaneous interpretation.

**3.2.3.2 panel description**

CR-DIG5202E1 vertical view:

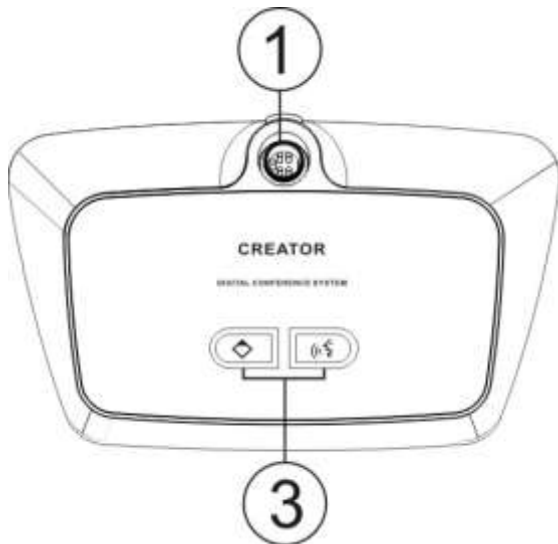

CR-DIG5204E1 vertical view:

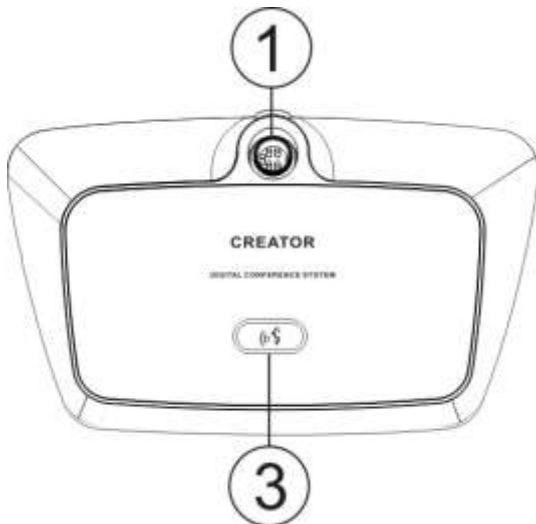

CR-DIG5202/04E1 side view:

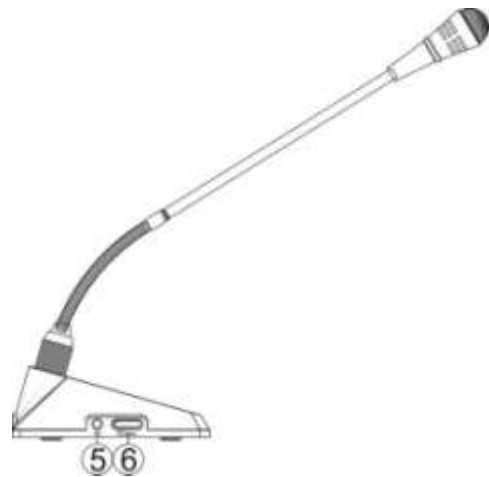

CR-DIG5202E2 / CR-DIG5202E3 vertical view:

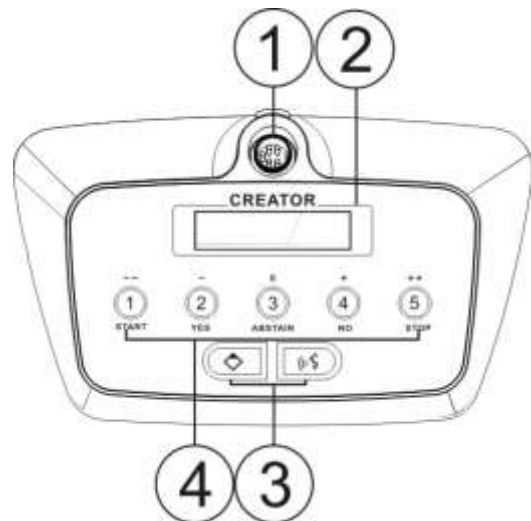

CR-DIG5204E2 / CR-DIG5204E3 vertical view:

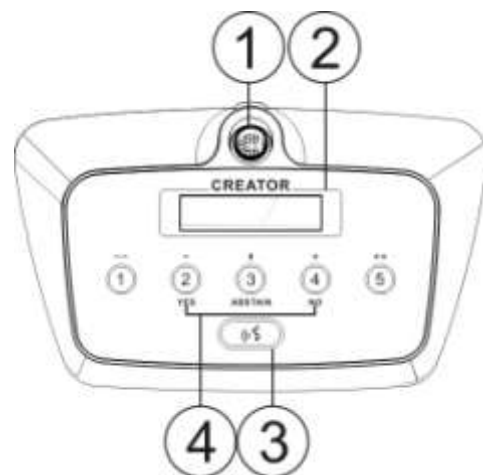



CR-DIG5202E2 / CR-DIG5202E3 side view:

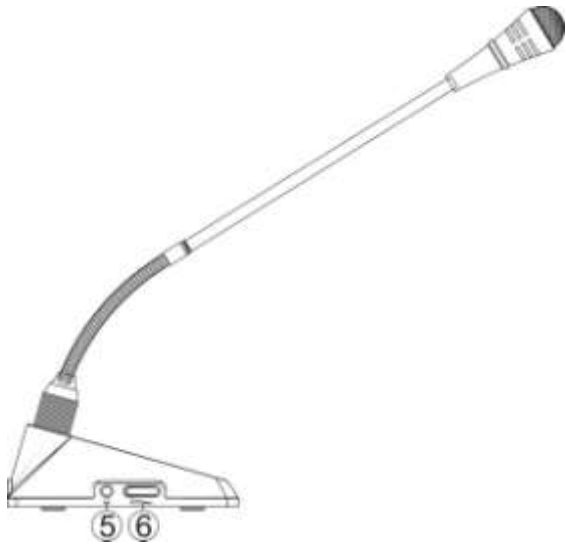

- ① headphone jack.
- ② 160x20 LCD display screen.
- ③ microphone button, Chairman priority button  
Press the Chairman unit priority button for 3 seconds, close all opened delegate speech unit.
- ④ multi-functional vote button  
——Meeting voting, numbers 2,3,4, respectively stands for in favor of, waiver, opposed.  
——Meeting election, numbers 1—5 respectively stand for different candidates.  
——Meeting rating, numbers 1—5 respectively stand for rank- - 0 + + +.
- ⑤ headphone jack.
- ⑥ volume control knob

**3.2.3.3 technical parameters**

parameters	CR-DIG5202/04E1
Power supply	The host power
Frequency response	20Hz~20KHz
Single to noise rate	> 80dB
Channel cross talk	> 80dB
Total harmonic	<0.05%
Power consumption	1.1W

Display screen	no
Simultaneous interpretation	no
Unit interface	8 core aerial head
color	Dark gray

parameters	CR-DIG5202/04E2
Power supply	The host power
Frequency response	20Hz~20KHz
Single to noise rate	> 80dB
Total harmonic	> 80dB
Power consumption	<0.05%
Power consumption	1.5W
Display screen	c)
Simultaneous interpretation	no
Unit interface	8 core aerial head
color	Dark gray

parameters	CR-DIG5202/04E3
Power supply	The host power
Frequency response	20Hz~20KHz
Single to noise rate	> 80dB
Channel cross talk	> 80dB
Total harmonic	<0.05%
Power consumption	1.5W
Display screen	8 core aerial head
Simultaneous interpretation	31+1
Unit interface	8 core aerial head

color	Dark gray
-------	-----------

### 3.2.4 CR-DIG5202/4D2 speech unit

CR-DIG5202/4D2 is a low-cost digital speech unit, integrate discussion, check-in, voting, and other functions in one.

#### 3.2.4.1 Features

- ◆ Chairman unit has priority to shut down the speaking unit.
- Chairman Unit has the function of initiating vote, and ending the voting;
- ◆ Chairman unit can initiate three key vote (support/abstain/against) to end vote;
  - ◆ 160X20 dot matrix displays sign results, voting, results;
- Support English display
- ◆ supports three vote ways:;
- A) method of voting: support/abstain/against  
 B) the manner of election : 1/2/3/4/5  
 C) responds / Review Mode: --, -, 0, +, ++
- ◆ no channel selection, no speaker, can only listen to the original sound channel.

#### 3.2.4.2 panel description

CR-DIG5202D2 vertical view:

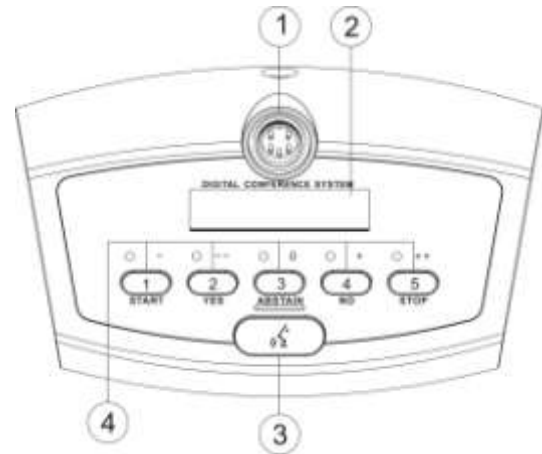

CR-DIG5202/4D2 side view:

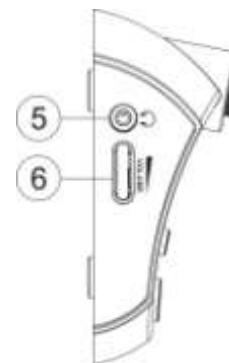

- ① headphone jack.
- ② 160x20 LCD display screen.
- ③ microphone button, Chairman priority button  
Press the Chairman unit priority button for 3 seconds, close all opened delegate speech unit.
- ④ multi-functional vote button  
——Meeting voting, numbers 2,3,4, respectively stands for in favor of, waiver, opposed.  
——Meeting election, numbers 1—5 respectively stand for different candidates.  
——Meeting rating, numbers 1—5 respectively stand for rank- - 0 + + +.
- ⑤ headphone jack.
- ⑥ volume control knob.

### 3.2.4.3 technical parameters

parameters	CR-DIG5202/04D2
Power supply	The host power
Frequency response	20Hz~20KHz
Single to noise rate	>80dB
Channel cross talk	>80dB
Total harmonic	<0.05%
Power consumption	1.6W
Mic parameters	
Mic core type	
sensitivity	-46dBV/pa
Frequency response	20Hz~20KHz
Input impedance	2.2K
Headphone output	>8
Headphone load	10mW
Headphone volume	
display	
Control display	160X20(blue white)
Unit interface	8 core aerial head
Dimensions(mm )	189.5LX93WX42.8H
color	Dark gray

### 3.2.5 Embedded unit

According to the application requirements of different occasions, the embedded unit of full digital conference system can choose to be used alone or be used in combination.

CR-DIG5202/4C1 is embedded pure speech unit;

CR-DIG5202/4C2 is embedded pure vote unit;

CR-DIG5206CH is embedded channel selection, Used to implement the cable simultaneous translation function;

CR-DIG5207SP is embedded speaker unit

#### 3.2.5.1 features

◆ Chairman unit has priority to shut down the speaking unit.

Chairman Unit has the function of initiating vote, and ending the voting;

◆ Chairman unit can initiate three key vote (support/abstain/against) to end vote;

◆ 320X64 displays sign results, voting, results;

◆ support Chinese English.

◆ no limit on the number.

◆ support 31+1 simultaneous interpretation;

◆ Can be used singly or together.;

◆ supports three vote ways.;

A) method of voting: support/abstain/against

B) the manner of election : 1/2/3/4/5

C) responds / Review Mode: --、-、0、+、++

#### 3.2.5.2 appearance size chart

CR-DIG5202/4C1、CR-DIG5206CH and CR-DIG5207SP are the same size , specific please see the below:

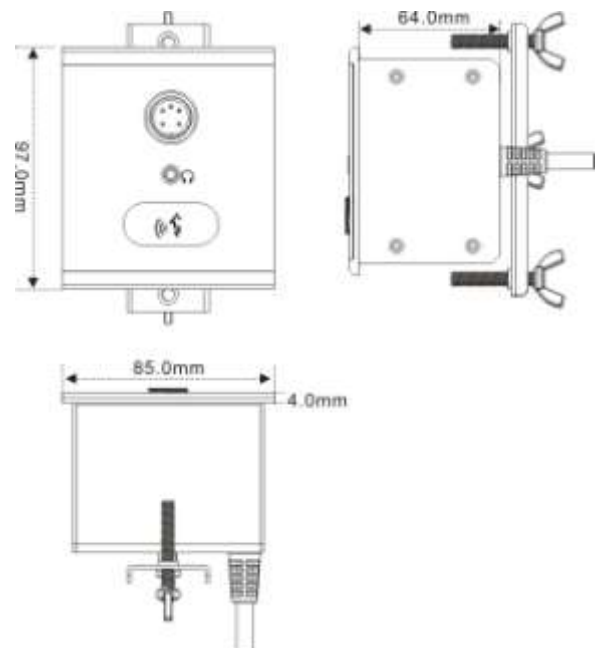

CR-DIG5202/4C2 appearance size chart:

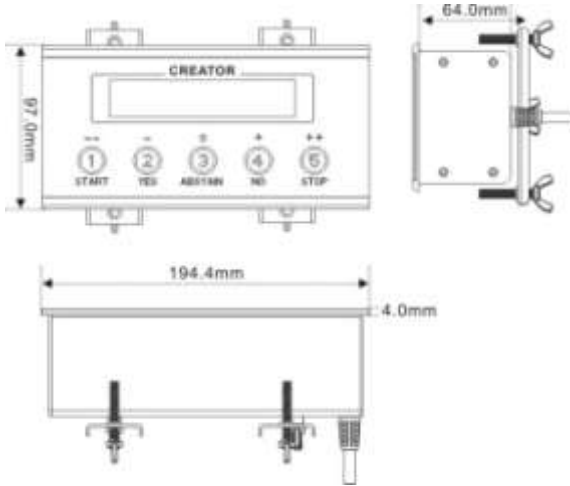

CR-DIG5206CH and CR-DIG5202/4C2 combine:

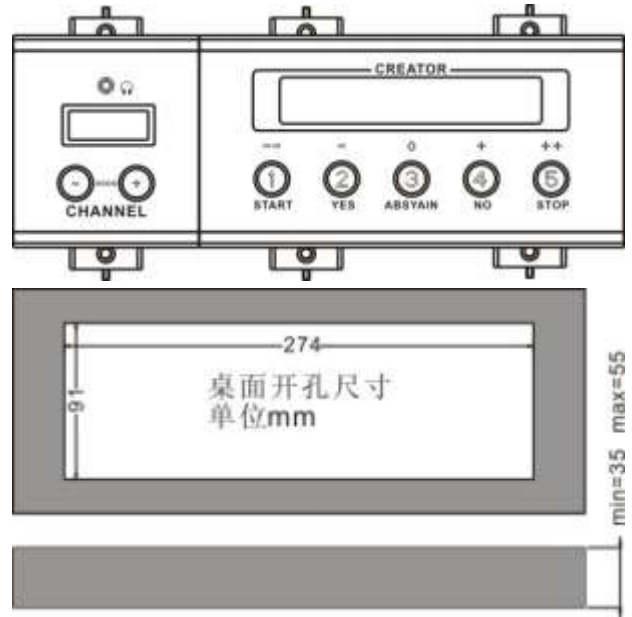

**3.2.5.3 installation instruction**

All digital conference system embedded units adopt desktop installation, directly open the desktop according to embedded units' size. Connect the signal lines and power lines to the host, then fix the embedded units on the desktop with the supplied screws, nuts, mounting bracket and wing nut. The size diagram as below:

The combination of CR-DIG5206、CR-DIG5207SP and CR-DIG5202/4C2 :

Hole size chart as below:

CR-DIG5202/4C1、CR-DIG5206CH and CR-DIG5207SP:

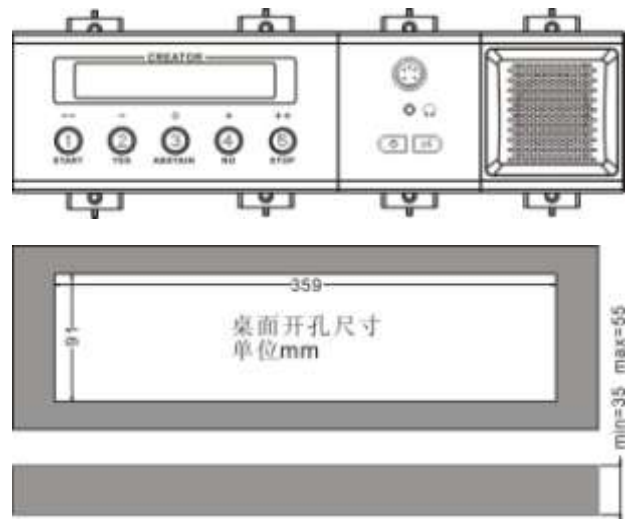
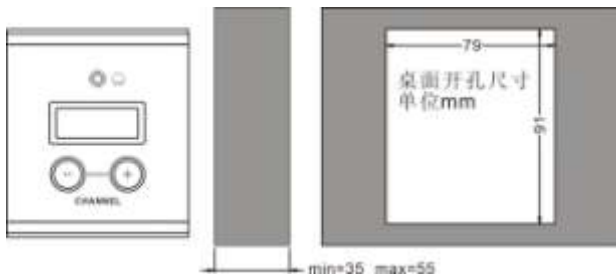

CR-DIG5202/4C2:

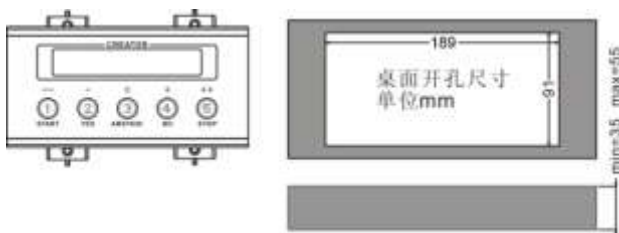

CR-DIG5206CH、CR-DIG5202/4C1 and CR-DIG5207SP:

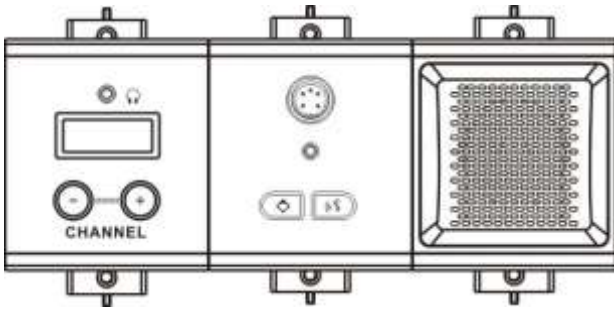

CR-DIG5202/4C1 and CR-DIG5207SP:

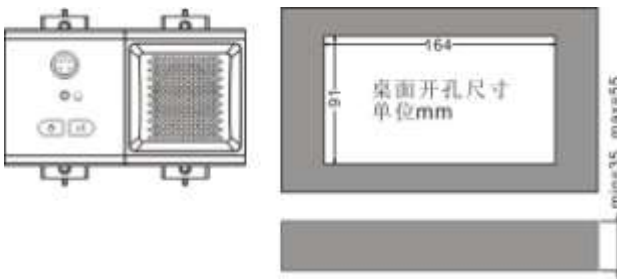

CR-DIG5202/4C1、CR-DIG5206CH、  
CR-DIG5207SP and CR-DIG5202/4C2:

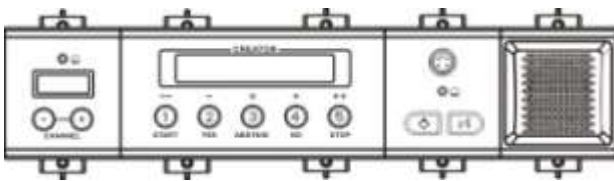

**Installation steps:**

- 1, open the desktop corresponding to the size;
- 2, install the embedded digital conference machine into the opened square hole of desktop;
- 3, install the fixing plate on pressure riveting screw under the machine;
- 4, fix the fixing plate with butterfly nut;
- 5, making M5X35 the butterfly screws go through the fixing plate to lock with desktop, so as to fix the equipment. As below::

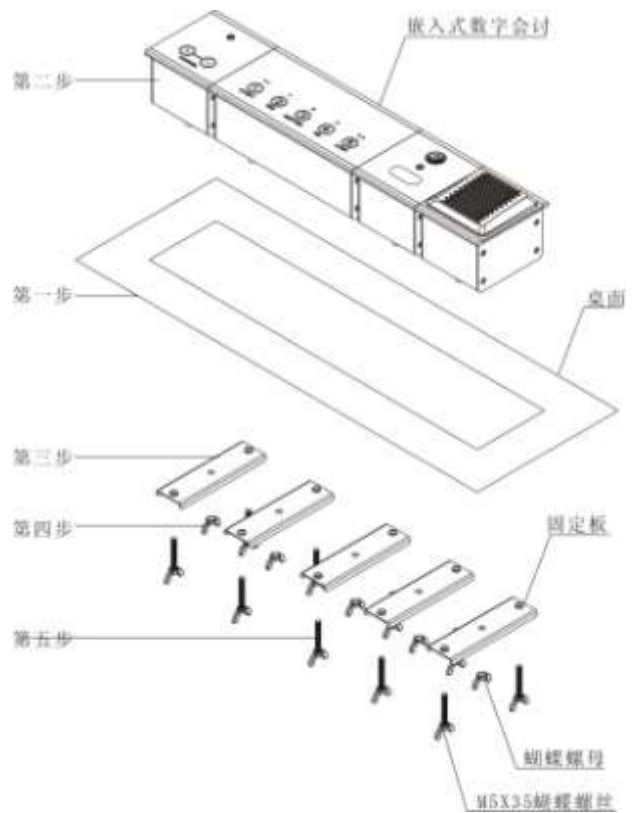

**3.2.5.4 panel description**

CR-DIG5206CH      CR-DIG5202C1 (chairman speech unit)

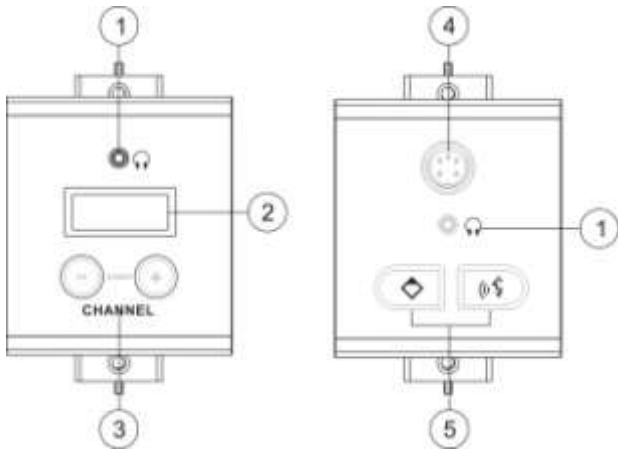

CR-DIG5204C1 ( delegate speech unit )

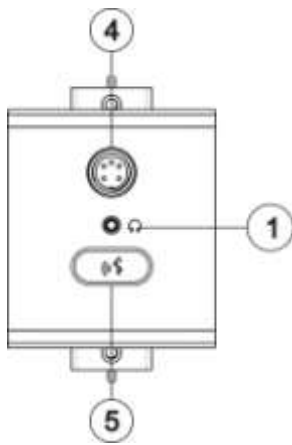

CR-DIG5207SP

CR-DIG5202/4C2

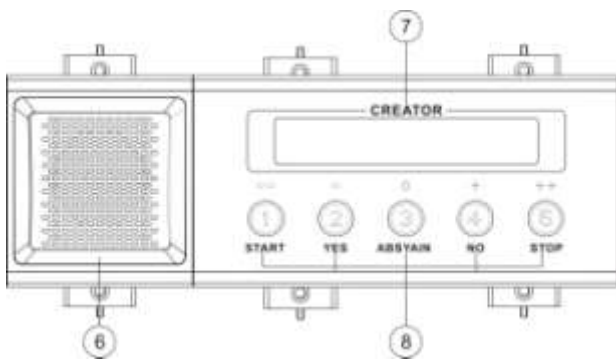

- ① headphone jack。
- ② channel selection (00-31) , channel number determined by host setting
- ③ channel selection button。
- ④ mic jack。

- ⑤ microphone button, Chairman priority button  
Press the Chairman unit priority button for 3 seconds, close all opened delegate speech unit
- ⑥ speaker
- ⑦ LCD display
- ⑧ multi-functional vote button  
——Meeting voting, numbers 2,3,4, respectively stands for in favor of, waiver, opposed.  
——Meeting election, numbers 1—5 respectively stand for different candidates.  
——Meeting rating, numbers 1—5 respectively stand for rank- - 0 + + +。

**3.2.5.5 technical parameters**

parameters	CR-DIG5202/04C1
Power supply	The host power
Frequency response	20~20KHz
Single to noise rate	>80dB
Channel talkcross	>80dB
Total harmonic	<0.05%
Power consumption	1.1W
Mic parameters	
Mic core type	
sensitivity	-46dBV/pa
Frequency response	20~20KHz
Input impedance	2.2K
Headphone output	>8
Headphone load	10mW
Headphone volume	
Unit interface	8 core aerial head
Dimensions(m)	80LX95WX60H

m)	
color	black
parameters	CR-DIG5202/04C2
Power supply	The host power
Power consumption	1.5W
Display Control display	320X64
Unit interface	8 core aerial head
Dimensions(m m)	188.4LX95WX60H
color	black
parameters	CR-DIG5206CH
Power supply	The host power
Frequency response	20~20KHz
Signal to noise rate	>80dB
Channel talkcross	>80dB
Total harmonic	<0.05%
Power consumption	1.1W
Headphone output	>8 10mW
Headphone load	
Headphone volume	
Unit interface	8 core aerial head
Dimensions(m m)	80LX95WX60H
color	black
parameters	CR-DIG5207SP
speaker	2W
Dimension (mm)	80LX95WX60H
color	black

## 3.2.6 Embedded II generation

### unit

#### 3.2.6.1 Touch

According to the application requirements of different occasions, the II generation embedded unit of full digital conference system can choose to be used alone or be used in combination.

CR-DIG5202/4C1-S is embedded pure speech unit;

CR-DIG5202/4C2-S is embedded pure vote unit;

◆ CR-DIG5206CH-S embedded channel selection, Support 31+1channel simultaneous interpretation。

#### 3.2.6.1.1 features

◆ Chairman unit has priority to shut down the speaking unit.

Chairman Unit has the function of initiating vote, and ending the voting;

◆ Chairman unit can initiate three key vote (support/abstain/against) to end vote;)

◆ Support 31+1 channel simultaneous interpretation。

◆ supports three vote ways:;

A) method of voting: support/abstain/against

B) the manner of election : 1/2/3/4/5

C) responds / Review Mode: --、-、0、+、++

#### 2.2.6.1.2 appearance size chart

CR-DIG5202/4C1-S appearance size chart:

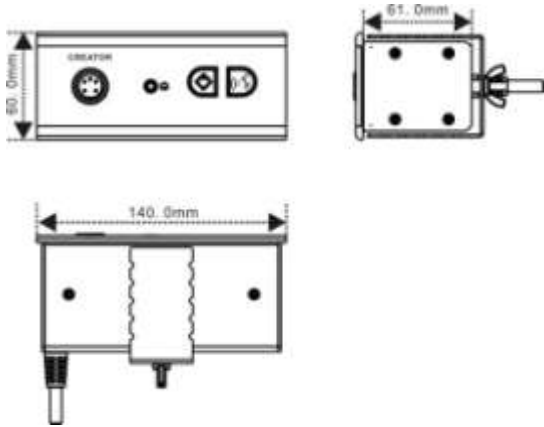

CR-DIG5202/4C2-S appearance size chart: :

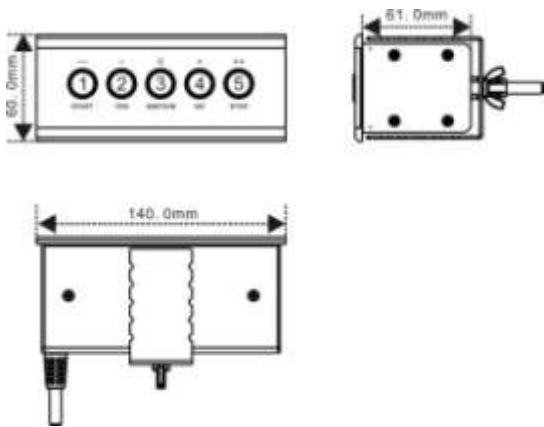

CR-DIG5206CH-S appearance size chart: :

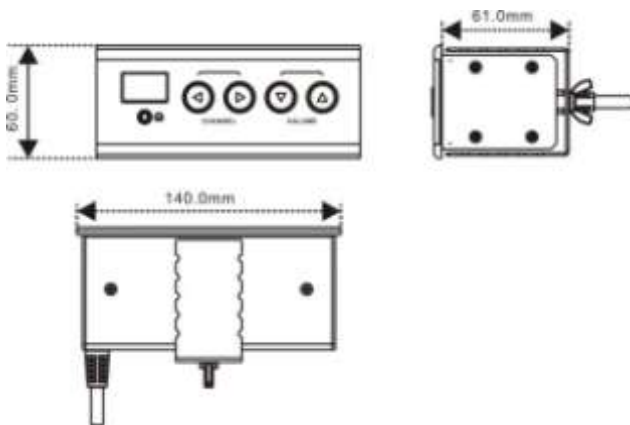

CR-DIG5207SP-S appearance size chart: :

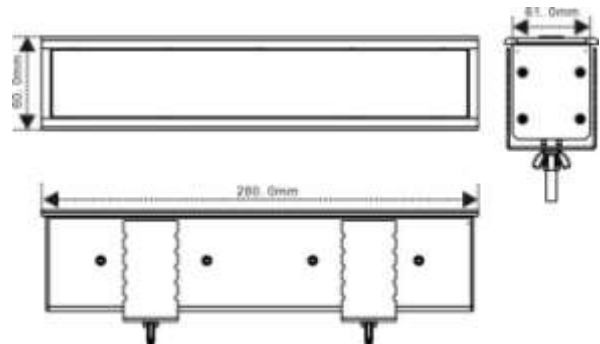

3.2.6.1.3 Installation steps:

Installation steps:

- 1, open the desktop corresponding to the size;
- 2, install the embedded digital conference machine into the opened square hole of desktop;
- 3, install the fixing plate on pressure riveting screw under the machine;
- 4, fix the fixing plate with butterfly nut;
- 5, making M5X35 the butterfly screws go through the fixing plate to lock with desktop, so as to fix the equipment. As below::

Hole size as below:

CR-DIG5202/4C1-S:

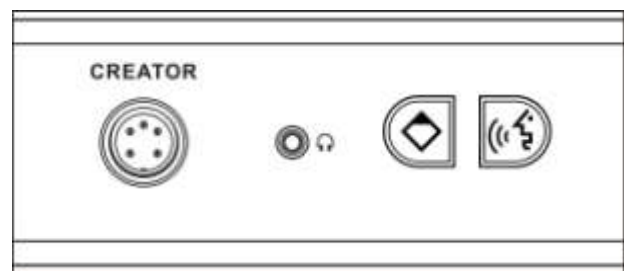





CR-DIG5202/4C2-S:

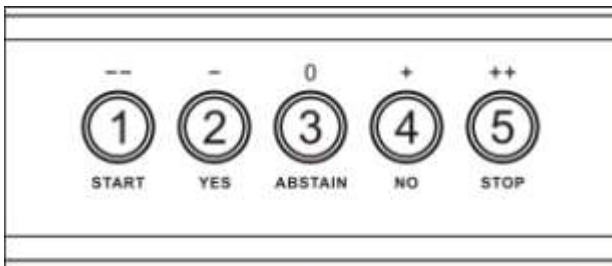

CR-DIG5207SP-S:

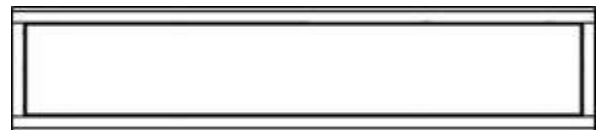

CR-DIG5202/4C1-S and CR-DIG5202/4C2-S:



CR-DIG5206CH-S:



CR-DIG5202/4C1-S 、 CR-DIG5202/4C2-S and CR-DIG5207SP-S



CR-DIG5202/4C1-S and CR-DIG5207SP-S



CR-DIG5202/4C1-S,CR-DIG5202/4C2-S and CR-DIG5207SP-S

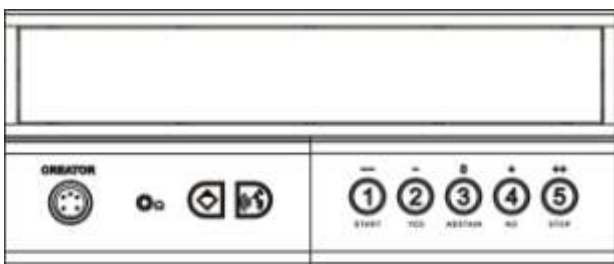

**2.Installation steps:**

- 1,open the desktop corresponding to the size;
- 2,install the embedded digital conference

machine into the opened square hole of desktop;

3.install the fixing plate on pressure riveting screw under the machine;

4.fix the fixing plate with butterfly nut; making M5X35 the butterfly screws go through the fixing plate to lock with desktop, so as to fix the equipment. As below::

**Hole size as below:**

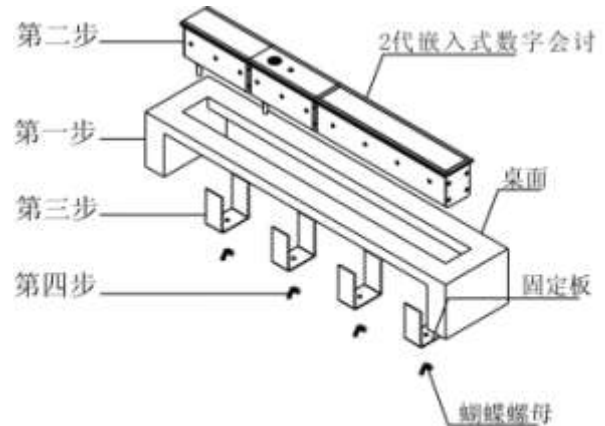

**3.2.6.1.4 panel description**

CR-DIG5202C1-S (chairman speech unit)

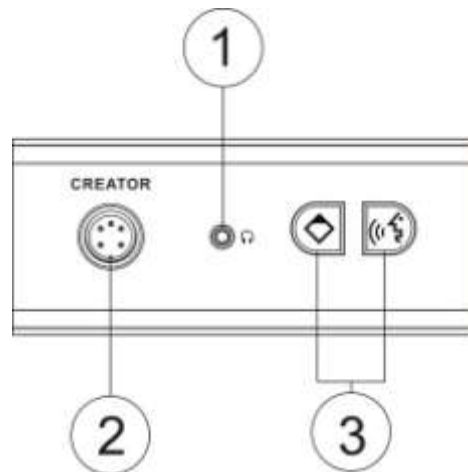

CR-DIG5204C1-S (delegate speech unit)

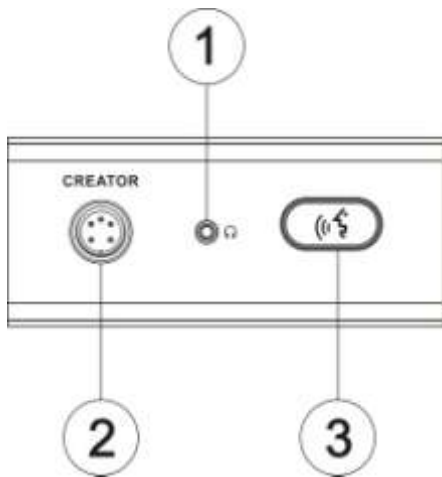

CR-DIG5202C2-S (chairman vote unit)

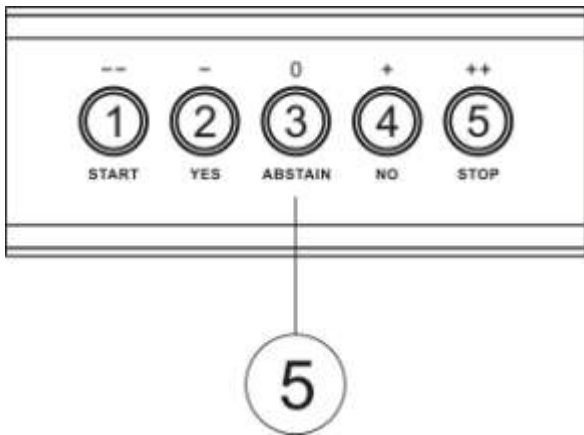

CR-DIG5204C2-S (delegate vote unit)

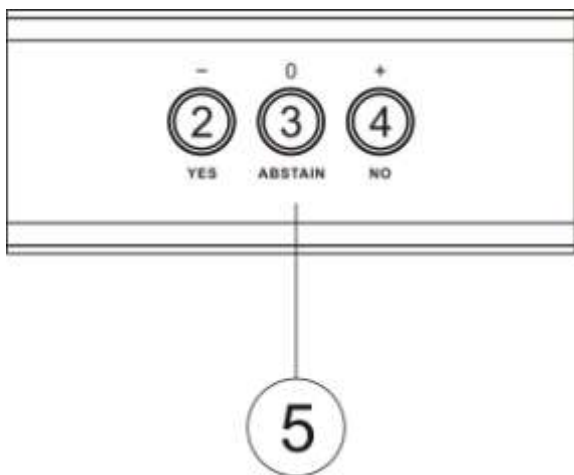

CR-DIG5206CH-S (channel unit)

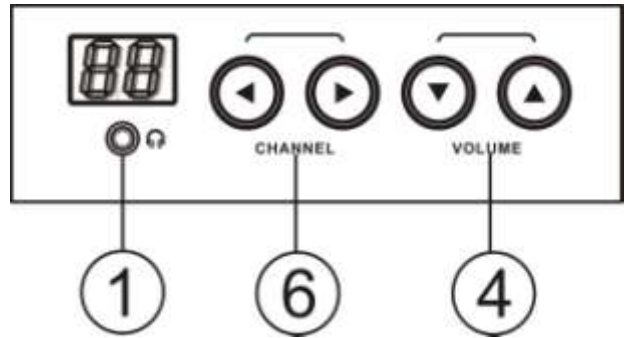

- ① Headphone jack.
- ② Mic jack
- ③ microphone button, Chairman priority button  
Press the Chairman unit priority button for 3 seconds, close all opened delegate speech unit
- ④ VOLUME—volume control
- ⑤ Multi function vote button  
—Meeting voting, numbers 2,3,4, respectively stands for in favor of, waiver, opposed.  
—Meeting election, numbers 1—5 respectively stand for different candidates.  
—Meeting rating, numbers 1—5 respectively stand for rank- - 0 + + +.
- ⑥ CHANNEL—channel selection, channel range (00-31), the channel determined by host setting.

 **“female interface” is connect to the front conference unit, “male interface” is connect to next conference unit.**

**2.2.6.1.5 technical parameters**

parameters	CR-DIG5202/04C1-S
Power supply	The host power
Frequency response	20~20KHz
Single to noise rat	>80dB
Channel talkcross	<0.05%
Total harmonic	1.1W

Mic parameters	
Mic core type	
sensitivity	-46dBV/pa
Frequency response	20Hz~20KHz
Input impedance	2.2K
Headphone output	>8
Headphone load	10mW
Headphone volume	
Unit interface	8 core aerial head
Dimensions(mm )	140LX60WX60H
Color	black
parameters	CR-DIG5202/04C2-S
Power supply	The host power
Power consumption	1.5W
Unit interface	8 core aerial head
Dimensions(mm )	140LX60WX60H
color	black
parameters	CR-DIG5206CH-S
Power supply	The host power
Frequency response	20~20KHz
Single to noise rate	>80dB
Channel talkcross	>80dB
Total harmonic	<0.05%
Power consumption	1.1W
Headphone output	>8
Headphone load	10mW

Headphone volume	
Unit interface	8 core aerial head
Dimensions(mm )	85LX97WX64H
Color	black

### 3.2.6.2 button

According to the application requirements of different occasions, the II generation embedded unit of full digital conference system can choose to be used alone or be used in combination.

CR-DIG5202/4C1-S is embedded pure speech unit;

CR-DIG5202/4C1-C is embedded pure speech unit;

CR-DIG5202/4C2-C is embedded pure vote unit;

CR-DIG5206CH-C is embedded channel selection unit, support 31+1 simultaneous interpretation

#### 3.2.6.2.1 feature

- ◆ Chairman unit has priority to shut down the speaking unit.;
- ◆ Chairman Unit has the function of initiating vote, and ending the voting
- ◆ Chairman unit can initiate three key vote (support/abstain/against) to end vote;)
- ◆ Support 31+1 channel simultaneous interpretation。
- ◆ supports three vote ways:;
- A) method of voting: support/abstain/against
- B) the manner of election : 1/2/3/4/
- C) responds / Review Mode: --、-、0、+、++
- ◆ Support hand in hand

#### 3.2.6.2.2 appearance size chart

CR-DIG5202/4C1-C appearance size chart:

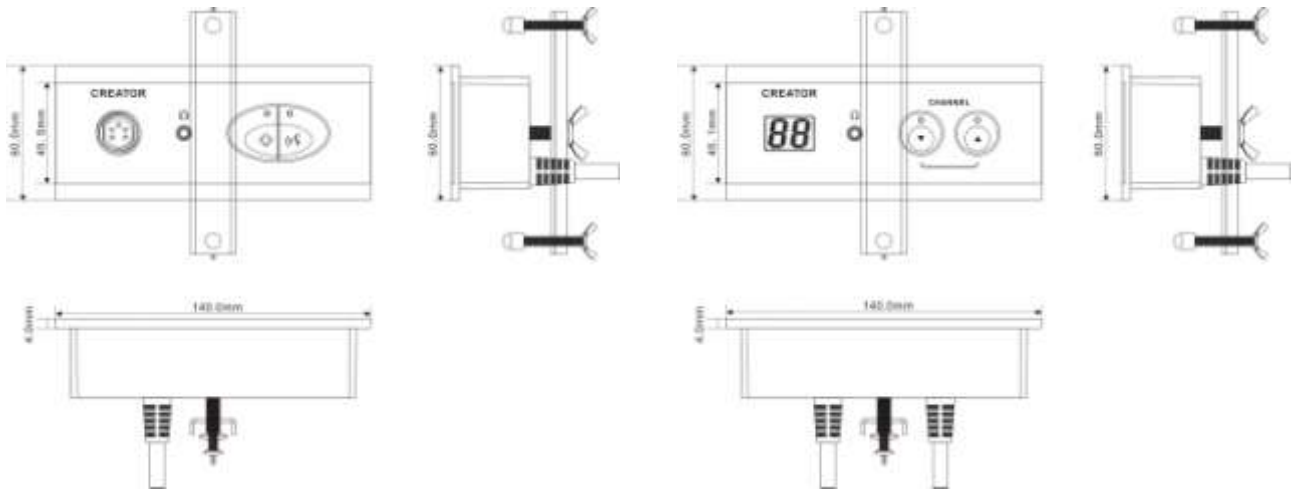

CR-DIG5202/4C2-C appearance size chart:

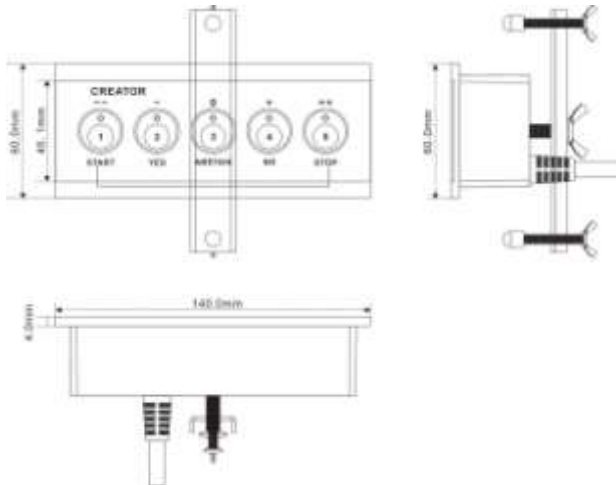

CR-DIG5206CH-C appearance size chart:

### 3.2.6.2.3 installation instruction

.Installation steps:

- 1,open the desktop corresponding to the size;
- 2,install the embedded digital conference machine into the opened square hole of desktop;
- 3.install the fixing plate on pressure riveting screw under the machine;;
- 4.fix the fixing plate with butterfly nut; making M5X35 the butterfly screws go through the fixing plate to lock with desktop, so as to fix the equipment. As below: :

Hole size as below:

CR-DIG5202/4C1-C:

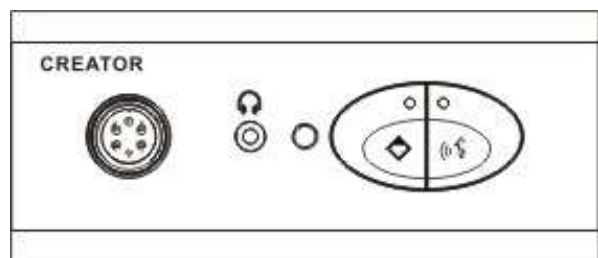



CR-DIG5202/4C1-C and CR-DIG5202/4C2-C:

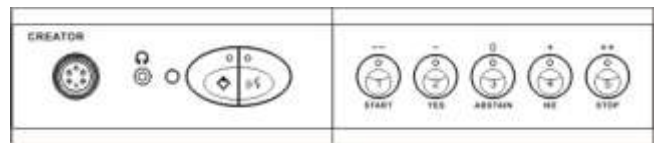

CR-DIG5202/4C2-C:

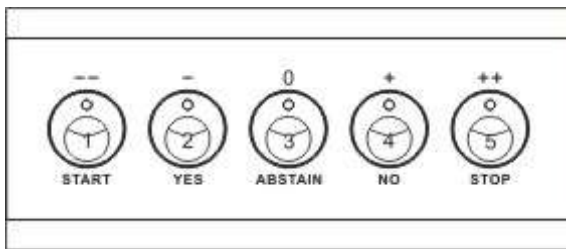

CR-DIG5202/4C1-C and CR-DIG5202/4C2-C  
、CR-DIG5206CH-C



CR-DIG5206CH-C

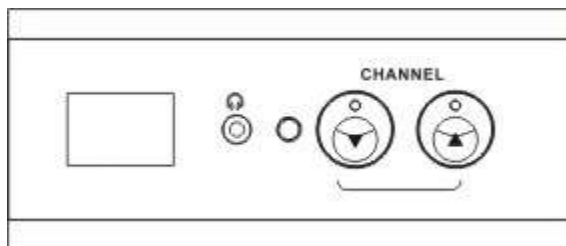

**Installation steps:**

- 1, open the desktop corresponding to the size;
- 2, install the embedded digital conference machine into the opened square hole of desktop;
- 3, install the fixing plate on pressure riveting screw under the machine;
- 4, fix the fixing plate with butterfly nut; making M5X35 the butterfly screws go through the fixing plate to lock with desktop, so as to fix the equipment. As below::

Hole size as below :

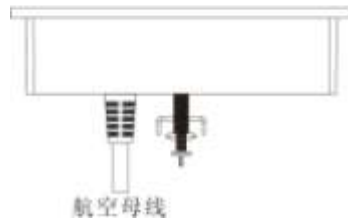
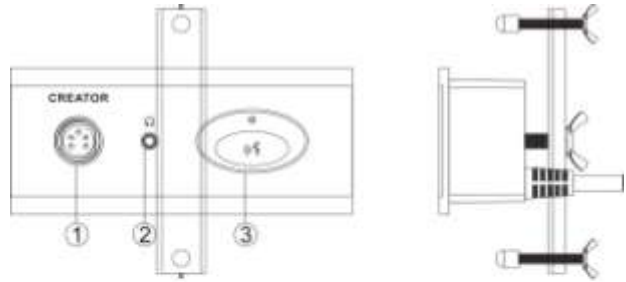
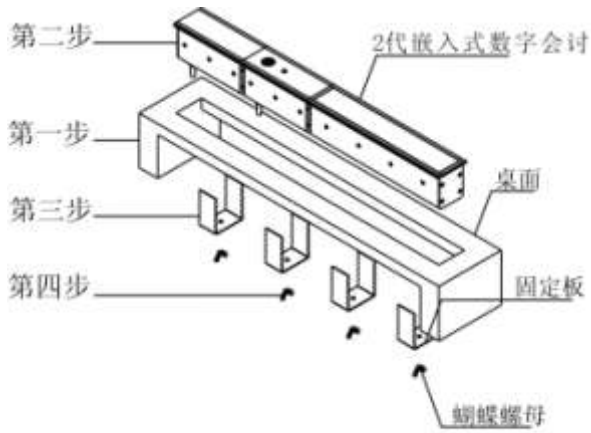

CR-DIG5202C2-C (chairman vote unit)

**3.2.6.2.4 description**

CR-DIG5202C1-C (chairman speech unit)

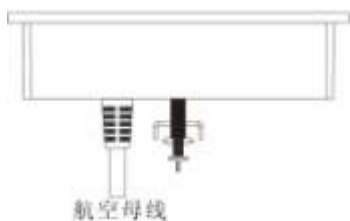
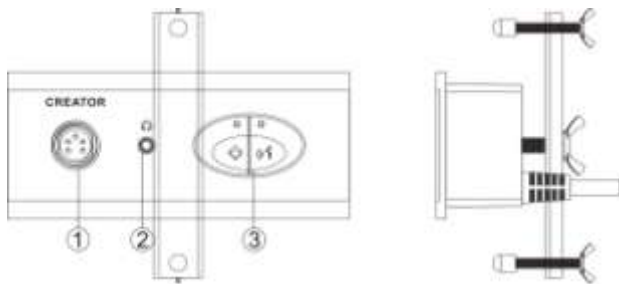

CR-DIG5204C1-C (delegate speech unit)

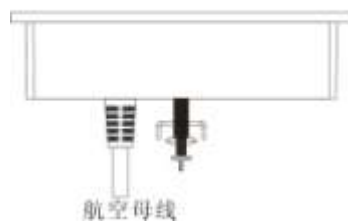
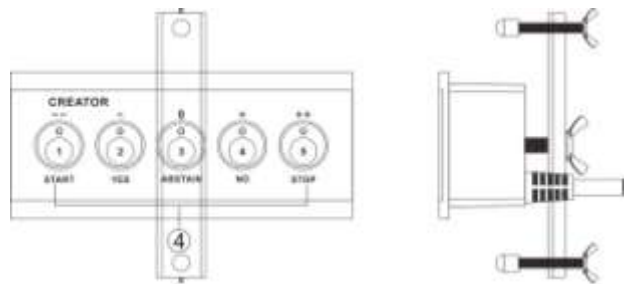

CR-DIG5204C2-C (delegate vote unit)

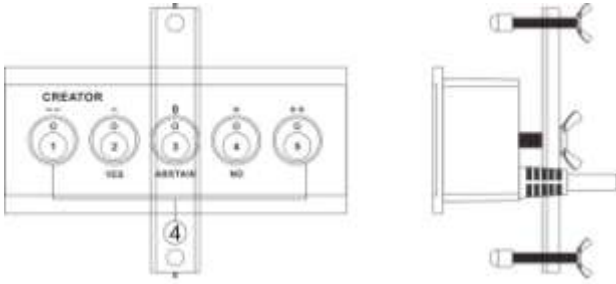

CR-DIG5206CH-C (channel selection)

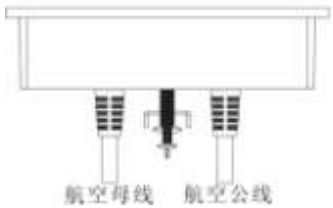
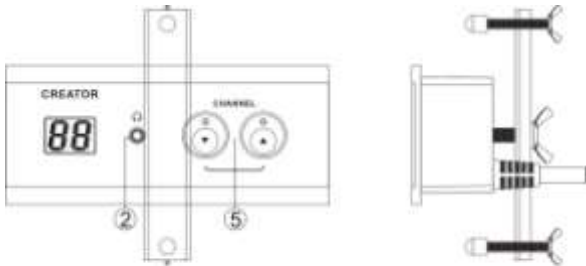

- ⑦ Headphone jack.
- ⑧ Mic jack
- ⑨ microphone button, Chairman priority button  
Press the Chairman unit priority button for 3 seconds, close all opened delegate speech unit
- ⑩ Multi function vote button  
——Meeting voting, numbers 2,3,4, respectively stands for in favor of, waiver, opposed.  
——Meeting election, numbers 1—5 respectively stand for different candidates.  
——Meeting rating, numbers 1—5 respectively stand for rank- - 0 + + +.

11 CHANNEL——CHANNEL——channel selection, channel range (00-31), the channel determined by host setting.



“female interface” is connect to the front conference unit, “male interface” is connect to next conference unit.

2.2.6.2.5 technical parameters

parameters	CR-DIG5202/04C1-C
Power supply	The host power
Frequency response	20~20KHz
Signal to noise rate	>80dB
Total harmonic	<0.05%
Power consumption	1.1W
Mic parameters	
Mic core type	
sensitivity	-46dBV/pa
Frequency response	20Hz~20KHz
Input impedance	2.2K
Headphone output	>8 10mW
Headphone load	
Headphone volume	
Unit interface	8 core aerial head
Dimensions(mm )	140LX60WX60H
Color	black
parameters	CR-DIG5202/04C2-C
Power supply	The host power
Power	1.5W



consumption	
Unit interface	8 core aerial head
Dimensions(mm )	140LX60WX60H
Color	black
parameters	CR-DIG5206CH-C
Power supply	The host power
Frequency response	20~20KHz
Single to noise rate	>80dB
Channel talkcross	>80dB
Total harmonic	<0.05%
Power consumption	1.1W
Headphone output	>8
Headphone load	10mW
Headphone volume	
Unit interface	8 core aerial head
Dimensions(mm )	85LX97WX64H
Color	black

### 3.2.7 Embedded CAT5 interface speaking and voting unit

CR-CAT5202/4C1 is an embedded cat5 interface speech unit used with the connection box;

CR-CAT5202/4C2 is an embedded cat5 interface vote unit used with the connection box ;

CR-CAT5206CH is an embedded cat5 interface 31+1 channel simultaneous interpretation unit used with the connection box;

CR-CAT5207SP is an embedded cat5 interface speech unit used with the connection box;

o

#### 3.2.7.1 Features

- ◆ Support hand in hand with air line, support hot plug;
- ◆ Each embedded CAT5 interface connection box support 1 CR - CR - CAT5202 CAT5202/4 c1, 1/4 c2, 1 CR - CAT5206CH flexible connection combination, can be used or combined
- ◆ An embedded cat5 interface connection box biggest support to connect to 2 units. each unit can realize speech, vote, simultaneous interpretation, horn amplification. etc function.
- ◆ Signal indicator, indicate circuit connection error, for the convenience of analyzing trouble;
- ◆ Chairman unit has priority to shut down the speaking unit.;
- ◆ capacitive touch key, no mechanical noise, waterproof, durable, easy to clean;
- ◆ Embedded CAT5 interface unit ultra small size, convenient armrest chair, all kinds of conference table installation;
- ◆ Embedded CAT5 interface connection box and embedded CAT5 unit support common super five kinds of wiring, convenient installation;
- ◆ The chairman unit can launch sign in, and end to sign in
- ◆ 31+1 channel simultaneous interpretation;
- ◆ Low power consumption , 2 units power consumption not more than 1.5W
- ◆ supports three vote ways:;
  - A) method of voting: support/abstain/against
  - B) the manner of election : 1/2/3/4/5
  - C) responds / Review Mode: --, -, 0, +, ++

**3.2.7.2 appearance size chart**

CR-CAT5202/04C1 appearance size chart:

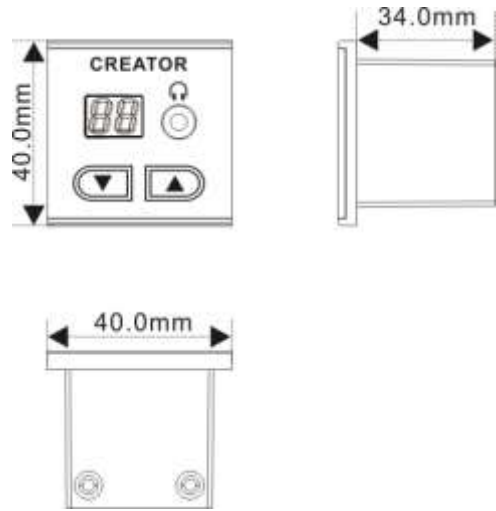
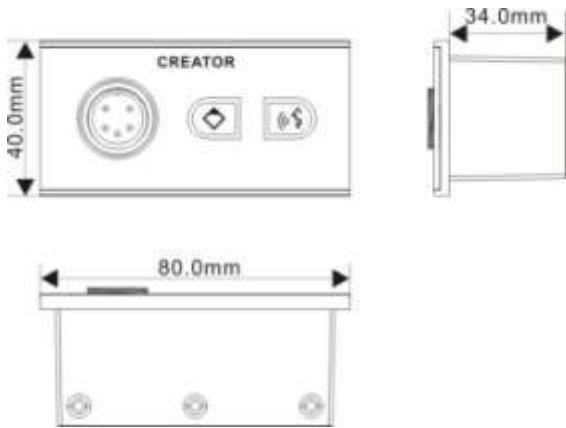

CR-CAT5202/04C2 appearance size chart:

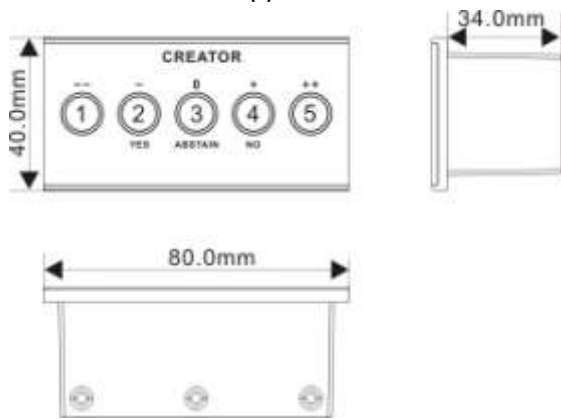

CR-CAT5207SP appearance size chart:

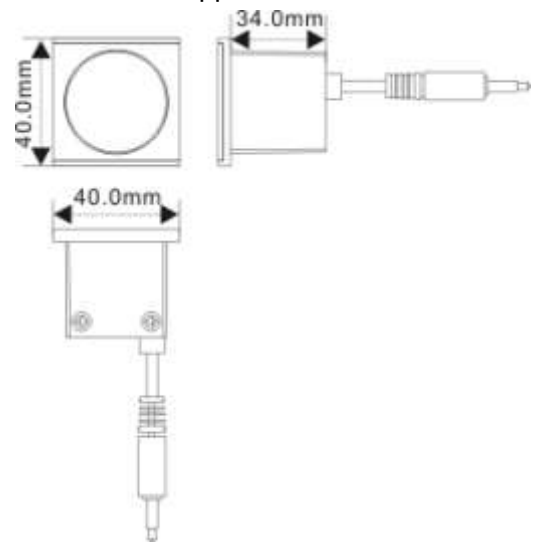

**3.2.7.3 installation instruction**

**Hole size as below:**

CR-CAT5202/04C1、CR-CAT5202/04C2

CR-CAT5206CH appearance size chart:

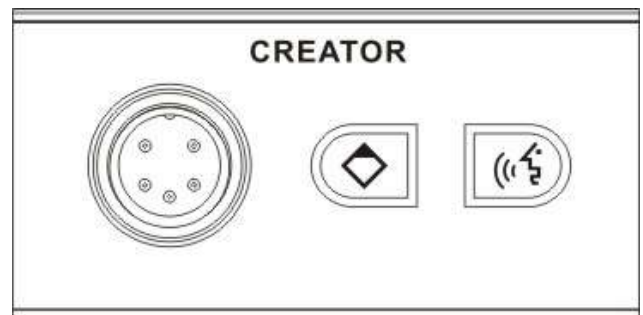

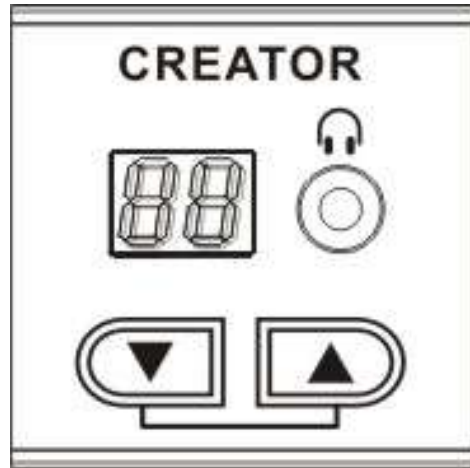
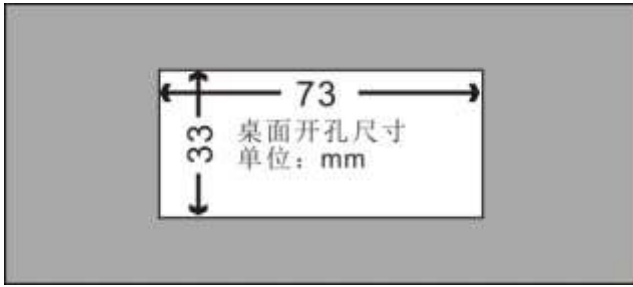

CR-CAT5202/04C1、CR-CAT5202/04C2:

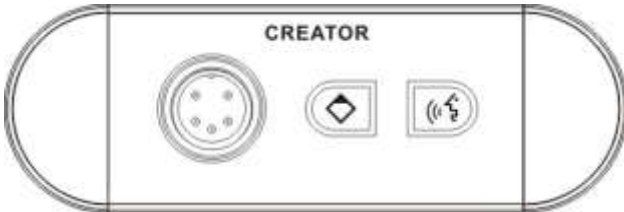

CR-CAT5206CH hole size chart:

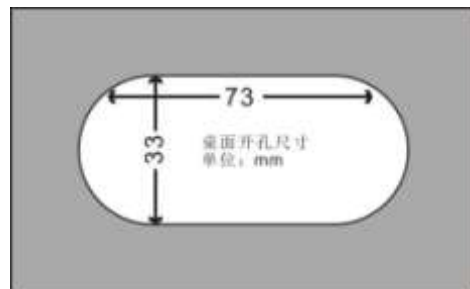
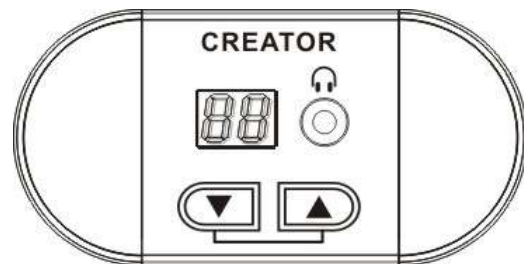

CR-CAT5206CH

CR-CAT5207SP hole size chart:

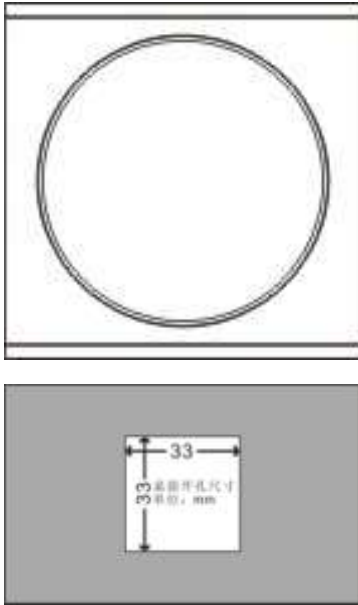

CR-CAT5207SP and CR-CAT5202/04C2 combine:



CR-CAT5207SP hole size chart:

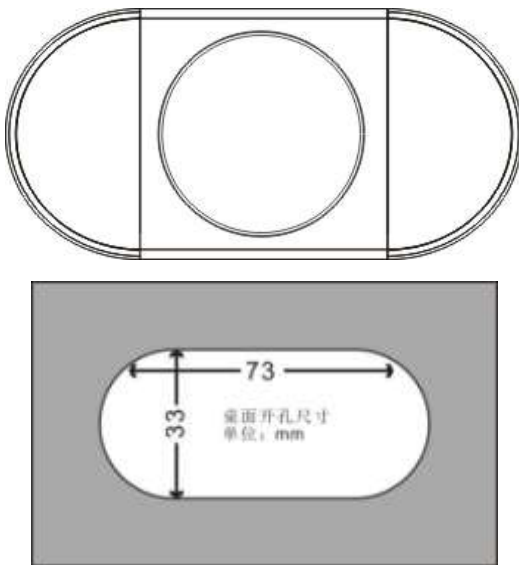

CR-CAT5207SP、CR-CAT5206CH、CR-CAT5202/04C1 and CR-CAT5202/04C2 combine:

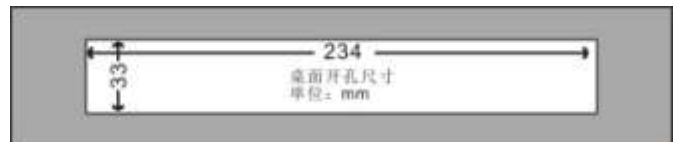

CR-CAT5207SP、CR-CAT5206CH、CR-CAT5202/04C1 和 CR-CAT5202/04C2 combine:



CR-CAT5207SP and CR-CAT5202/04C2 combine:

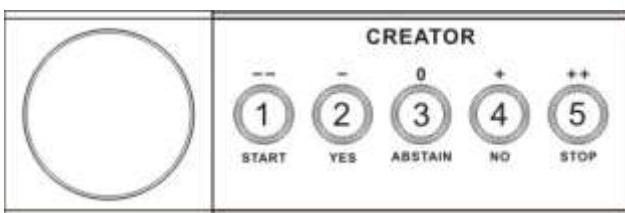

CR-CAT5206CH and CR-CAT5202/04C2 combine:



CR-CAT5206CH and CR-CAT5202/04C2 combine:



CR-CAT5207SP、CR-CAT5206CH and CR-CAT 5202/04C2 combine:

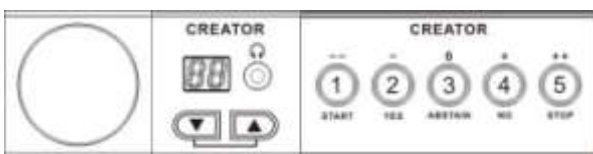

CR-CAT5207SP、CR-CAT5206CH and CR-CAT 5202/04C2 combine:

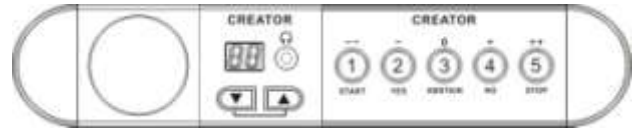

### 3.2.7.4 panel description

CR-CAT5202C1

(embedded CAT5 interface chairman speech unit)

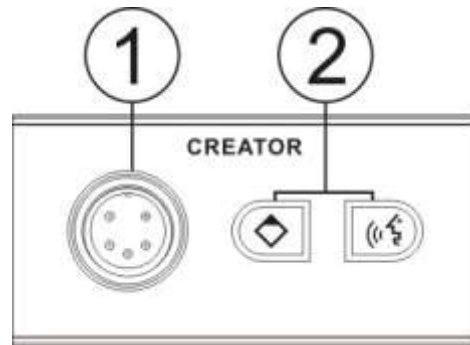

CR-CAT5204C1

(embedded CAT5 interface delegate speech unit)

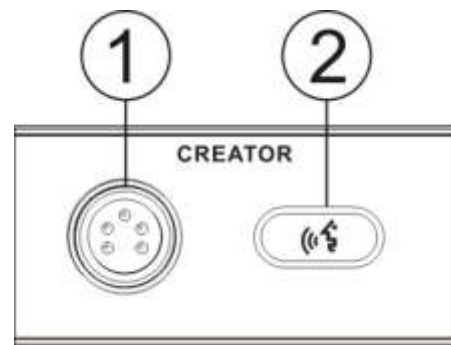

CR-CAT5202C2

(embedded CAT5 interface chairman vote unit)

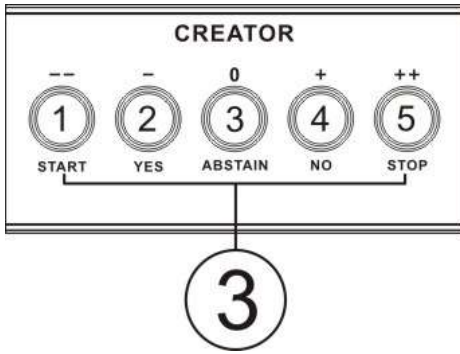

**CR-CAT5204C2**

(embedded CAT5 interface delegate vote unit)

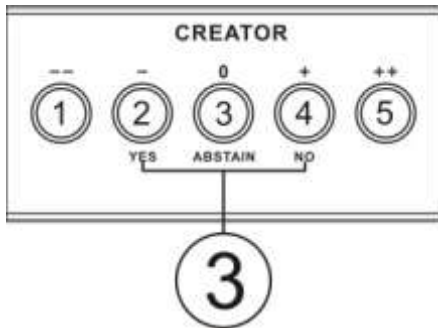

**CR-CAT5206CH**

(embedded CAT5 interface channel selection unit)

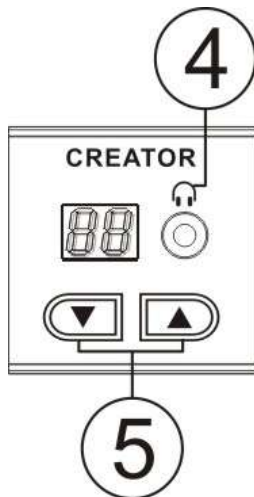

**CR-CAT5207SP**

(embedded CAT5 interface speaker unit)

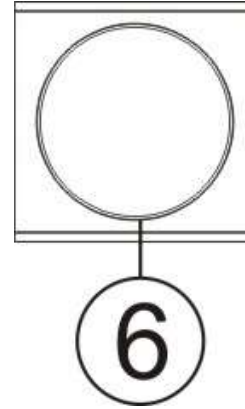

- ① Mic interface
- ② Microphone button, Chairman priority button  
Press the Chairman unit priority button for 3 seconds, close all opened delegate speech unit
- ③ Multi function vote button:  
Meeting voting numbers 2,3,4, respectively stands for in favor of, waiver, opposed.  
——Meeting election, numbers 1—5 respectively stand for  
  
different candidates.  
——Meeting rating, numbers 1—5 respectively stand for rank - - 0 + + +.
- ④ Headphone jack.
- ⑤ Channel selection button
- ⑥ speaker

**3.2.7.5 technical parameters**

parameters	CR-CAT5202/04C1
Single to noise rate	>80dB
Total harmonic	<0.05%
Mic parameters	
Mic core type	
sensitivity	-46dBV/pa
Frequency response	20Hz~20KHz
Input impedance	2.2K
Unit interface/number	CAT5 interface/2

Dimensions (mm)	80(L)x40(W)X34(H)
Power consumption	0.076W
weight	88g
Color	black
<b>parameters</b>	<b>CR-CAT5202/04C2</b>
Unit interface/number	CAT5 interface/2
Dimensions (mm)	80(L)x40(W)X34(H)
Power consumption	0.003W
weight	77g
color	black
<b>parameters</b>	<b>CR-CAT5206CH</b>
Frequency response	20Hz-20KHz
Single to noise rate	>80dB
Channel talkcross	>80dB
Total harmonic	<0.05%
Headphone output Headphone load Headphone volume	>8 10mW
Unit interface/number	CAT5 interface/1
dimensions (mm)	40(L)x40(W)X34(H)
Power consumption	0.044W
weight	41g
color	black
<b>parameters</b>	<b>CR-CAT5207SP</b>
speaker	1W
dimensions (mm)	40(L)x40(W)X34(H)

weight	74g
color	black

### 3.2.8 CR-CAT5BOX02/04

#### embedded CAT5 interface connection box

CR - CAT5BOX02/4 connection box is a full digital conference system support air line connect with hand in hand , maximum support to connect two sets of embedded CAT5 interface unit

##### 3.2.8.1 features

- ◆ "Hand in hand" type connection, support hot plug
- ◆ Each embedded CAT5 interface connection box support 1 CR - CR - CAT5 202 CAT5202/4 c1, 1/4 c2, 1 CR -CAT5206 CH flexible connection combination, can be used or combined.

##### 3.2.8.2 panel description

The panel picture:

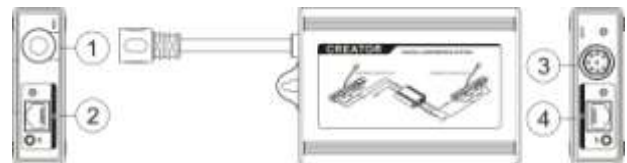

- ① LINK——connect to host or connection box
- ② D1——connect to speech or vote unit  
SP——embedded CAT5 speaker unit interface
- ③ NEXT——connect to next box or unit
- ④ D2——connect to speech or vote unit  
SP——embedded CAT5 speaker unit interface

##### 3.2.8.3 technical parameters

<b>parameters</b>	<b>CR-CAT5BOX02/04</b>
power supply	The host power

Unit interface /number	
Input output	A 1.5M 8 core air routes An 8 core air head, CAT5 interface x2, speaker 3.5mm Audio interface x2
Super cat5 cable	Not more than 50m
Power consumption	2 units is not more than 1.5W
weight	275g
dimensions (mm)	40(L)x40(W)X34(H)
color	Dark gray

### 3.2.9 VFD display unit

CR-DIG5205DS、CR-DIG5205DS-SVFD display unit CR-DIG5205DS、CR-DIG5205DS-S display Unit provides functions like electronic nameplate,tea applications,message display, and so on.

#### 3.2.9.1 features

- ◆ display unit 256X64 lattice display for identity information, support name,posts scroll off display or a separate display, support adaptive zoom, red text and white character to provide the best visual effect,support 8 characters, 16 letters of the alphabet, Russian and Japanese languages at the maximum
- ◆ all display units of the whole system scroll off synchronically,information;high bandwidth to transmit
- ◆ The all display unit of the whole system can Can implement turn over screen, left, right, and display synchronization;
- ◆ Resolve uncommon word display problems of Chinese characters;
- ◆ support PC software electronic

nameplate display, high bandwidth to transmit information;

- ◆ PC software can complete about 1000 unit electronic nameplate display content delivery in one second;
- ◆ provide short message and tea application service;
- ◆ provide front and back display of electronic nameplate, be convenient for finding seat and identification;
- ◆ high compatibility, can be used alone or with meeting units of DIG52 series which have no electronic nameplate display function.
- ◆ CR-DIG5205DS-S is a simplified version,can only display names and positions, no short message,no tea application function, no front identity display.

#### ◆ CR-DIG5205DS CR-DIG5205DS

Is the enhanced version which can display names and positions, short message, tea applications, and front identity.

#### 3.2.9.2 Descriptions of Appearance buttons

CR-DIG5205DS、CR-DIG5205DS-S front view:

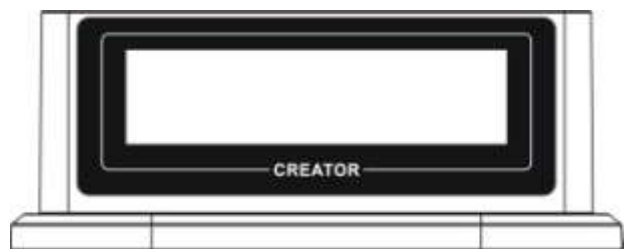

CR-DIG5205DS back view:



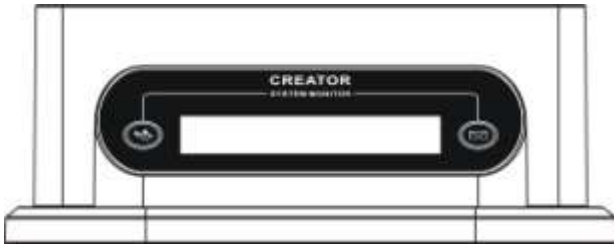

CR-DIG5205DS-S vertical view:

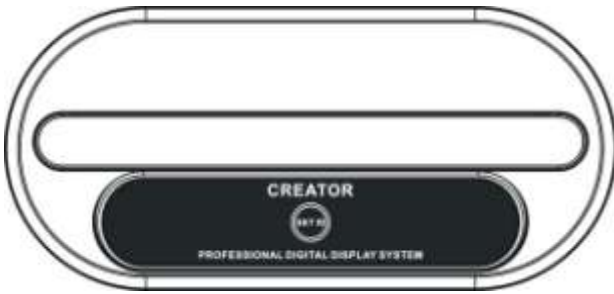

tea application button



message button



ID setting button

**3.2.9.3 technical parameters**

parameters	CR-DIG5205DS CR-DIG5205DS-S
Power supply	The host power
Power consumption	6W
Display screen Control display Table display	320X64lattice (blue white) 256X64lattice (blue white)
Unit interface	8 core air head
dimensions(mm)	233.5LX120WX101H
color	Dark gray

**3.3 VFD display unit management software**

All digital conference system VFD

display unit management software is a management software of CREATOR display unit. It is specially designed for separate or mixed display for name or position of electronic nameplate. It can send messages,do tea service, also can simultaneously manage multiple venues.

**3.3.1 features**

- ◆ support more than one venue management;
- ◆ modify or set the names and positions in single or multiple venues,support three modes of display: names or posts only, or mixed display of names and positions;
- ◆ Name and title display maximumly support 16 bytes, supports multiple languages
- ◆ setting forbidden units and open units;
- ◆ automatic access to the failures of online unit or test unit; ;
- ◆ can import / export names, positions, seat numbers edited in Excel format.

**3.3.2 Software interface and operating instructions**

**instructions**

Install the "Electronic table card display system"software correctly,double-click it,the main interface prompts as belows:



Interface is composed of "the venue management", "tea application list", "send message".

tea application switch.

Fill in correctly according to the parameter settings, click "OK" button creat a new venue, as shown below:

### 3.3.2.1 venues management

Right-click the space of "venues management", the following dialog box prompts:



Add new venue: To add a new venue.

Backup data: backup data to prevent abnormal loss

Import data: Import the edited file data.

Click the "Add new venue", enter the Setting dialog box to add a new venue:

New venue parameter settings:

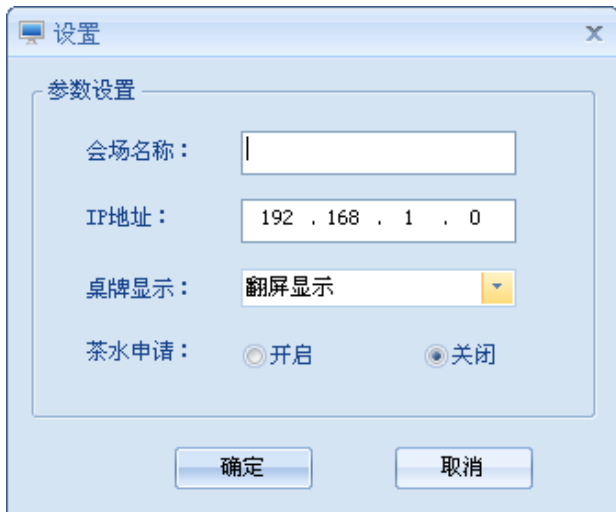

Newly created venue:



Venue Name: For the convenience of management, an easy-to-remember name is preferable.

IP address: in a network, IP addresses cannot overlap.

Card tables Display: three options available: scroll off display, name only display, post only display.

Tea application: the setting of discuss unit's

Upon completion of new venue, right-click on venue name and pops up the following dialog box.



Add staff: Add e-card tables show staff,add one person a time,enter the following interface:



Directly enter the desired ID number, name, Position.

Delete venue: To delete the entire venue content

Modify venue: to amend venue parameters, such as venue name, IP address, card tables, tea applications.

Connection:set up normal connection communication between the venue and system network. After click "Connect", the corner of main interface will display the network status of the venue (offline / online).

Unit testing: when the venue is online, detect if card tables system is online.。

Switching unit: set one or more discuss units disabled or enabled. Click to enter the dialog box:

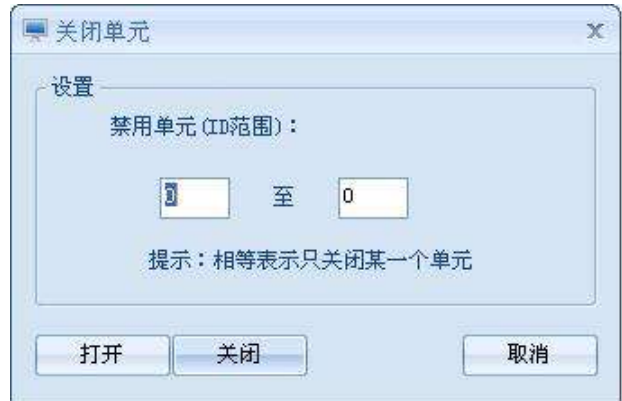

Enter in the ID numbers of discuss units to open /close.Then select open / close.

In venue personnel management, right-click the "personnel name", personnel management dialog will pop-up,such as:



Delete staff: To delete the current staff.

Modify staff: To modify the current personnel information.

There are three items just under "venue management",namely"Import","Export", "update personnel information

"Import: Import the names,positions, seat numbers edited in EXCEL format. EXCEL format editing shows as below:

	A	B	C	D	E
1	ID	姓名	职位	座位号	
2	1	张三	软件工程师	第一排1号	
3	2	李四	软件工程师	第一排2号	
4	3	王五	电子工程师	第一排3号	
5					

Export: export current venue Personnel information and save in EXCEL format.

Update personnel information: click this button when personnel information is incorrect or when there is a need to import new personnel information.

### 3.3.2.2 Tea application personnel list

When discuss units apply tea, the tea application list will show the applicant's information. As Shownbelow



Request processing is complete, right click the requester and choose "processed request" button.。

### 3.3.2.3 short message sending

The software provides short message sending service, choose the staff required to send in venue management list, enter message content, and then press "Send Message" button. The messages can be sent individually or collectivel



### 3.4 System connection diagram

The connection methods of all digital conference system speech units are similar. Now list several for reference. Specific connections are as follows:

Connection diagram one.

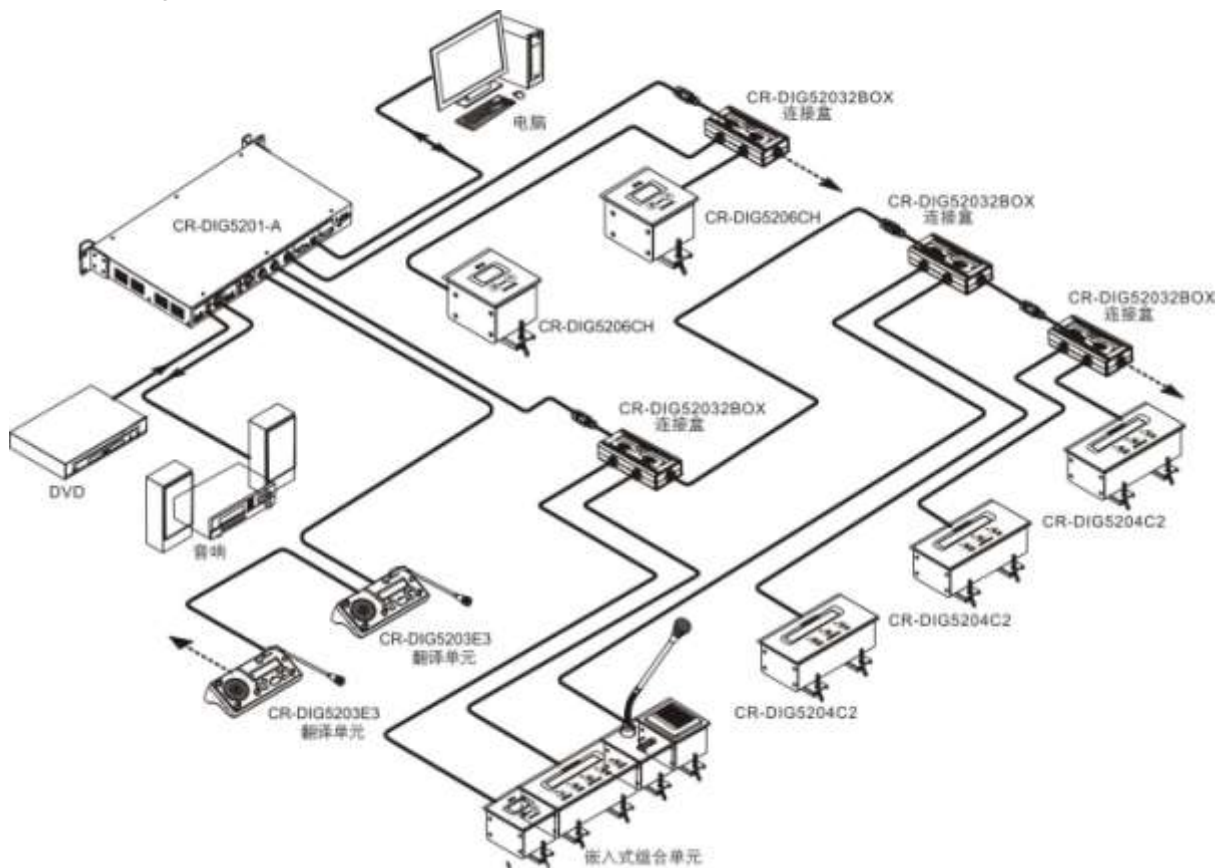

Connection diagram two.

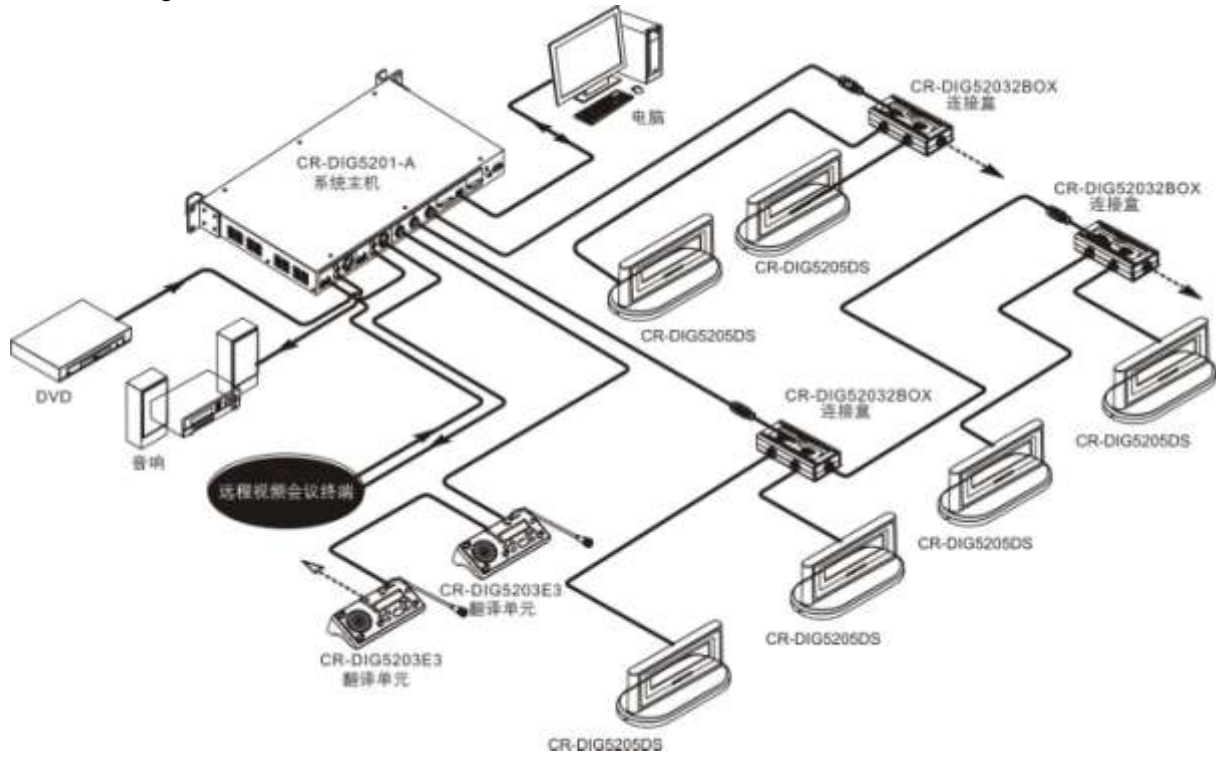

Connection diagram three.

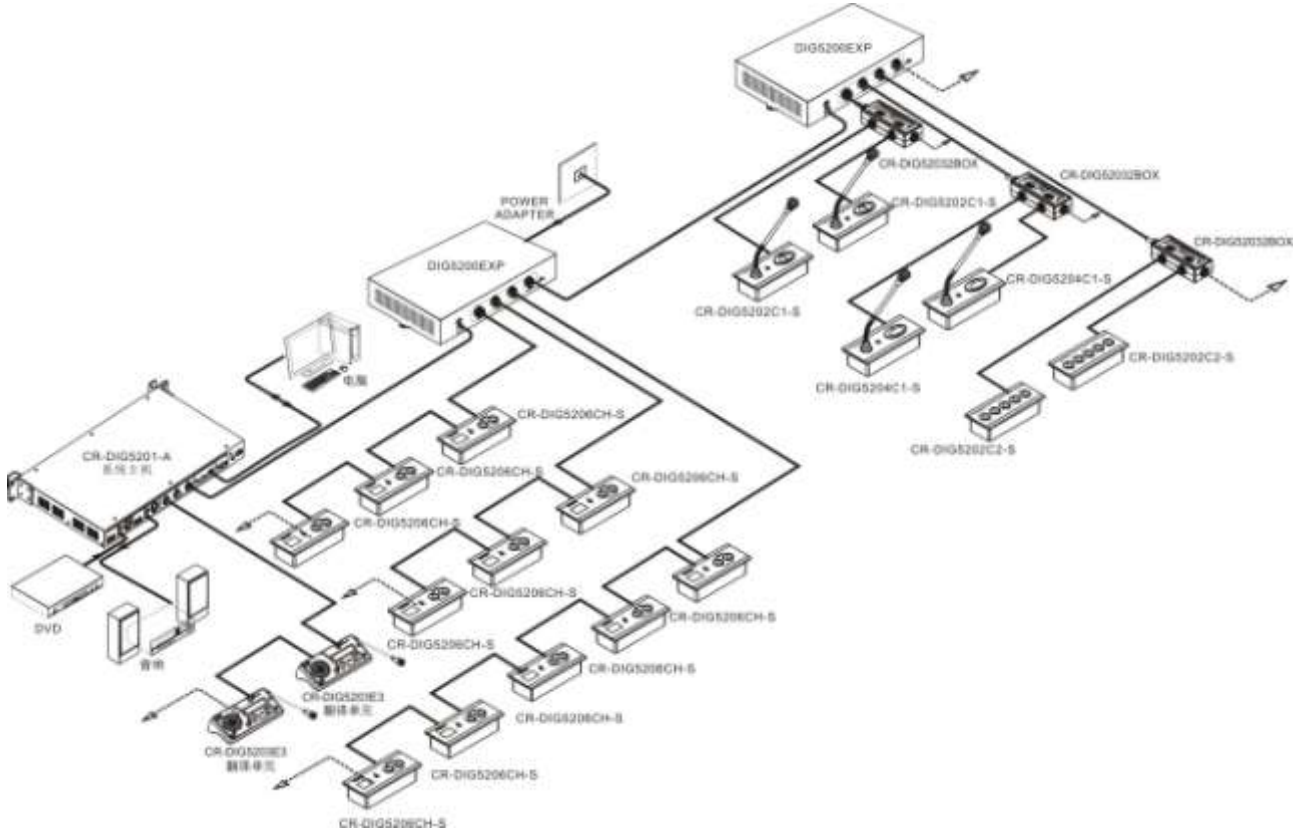

Connection diagram four.

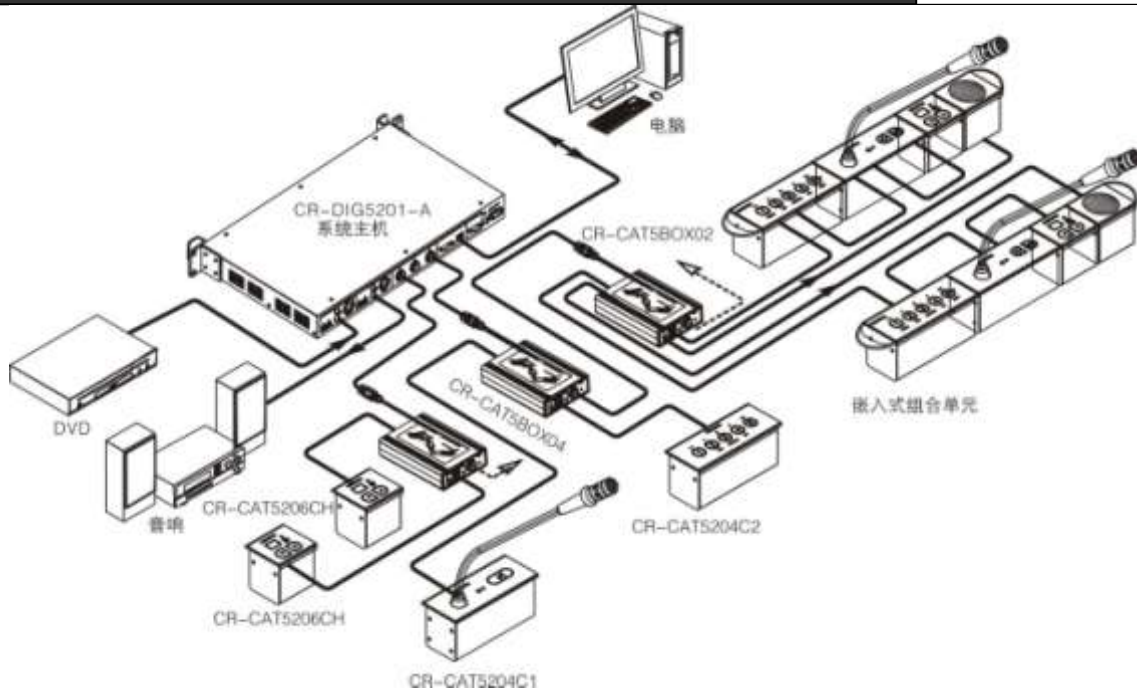

## Chapter4、 Conference system connection box

### 4.1 DIG52032BOX system connection box

CR-DIG52032BOX connection box has extended functionality and convenience of engineering applications, you can use it with CREATOR Conference units.

#### 4.1.1 features

- ◆ “ hand in hand ” way to connect;
- ◆ 8core high-density air interface, with nut knob connector, make the connect of the device more stable;
- ◆ each digital interface to connect two speech units;
- ◆ "LINK" interface is connected to the upper digital interface or directly connected to Conference host and active expansion connection box;

- ◆ connect to the next digital interface by "NEXT" interface.

#### 4.1.2 panel description

Front view:

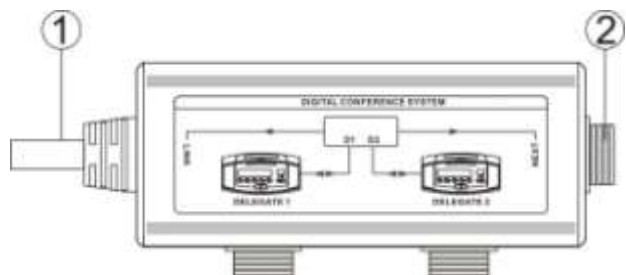

Side view:

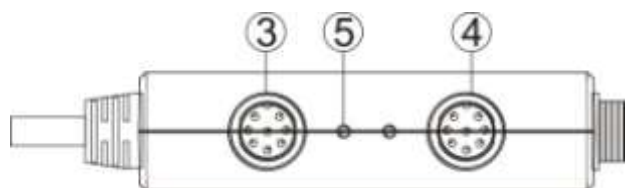



next connection box. Forbid to connect ③, ④ port to the next connection box. Even though the function is OK, the load capacity is comparatively weak.

### 4.1.3 technical parameters

parameters	CR-DIG52032BOX
Power Supply	The host power
Power consumption	0.9W
Input interface	
Input	One 1.5M 8 core air line
output	3 8 core air head
dimensions	135.6LX86W X28.8H (mm)
color	Dark gray

Side view:



① 2 meters air routes. connect to host or the upper digital interface box.

② connect to the next digital interface box.

③ connect to Conference unit.

④ connect to Conference unit

⑤ if connect ③ port to Conference units, connected properly, D1 indicator flashes. D1 indicator stays light, normal connections, no data. D1 indicator stays dark, abnormal connections or no connection. Similar to D2,.

Note: connect ②port (NEXT port) to the

#### 4.1.4 connection diagram

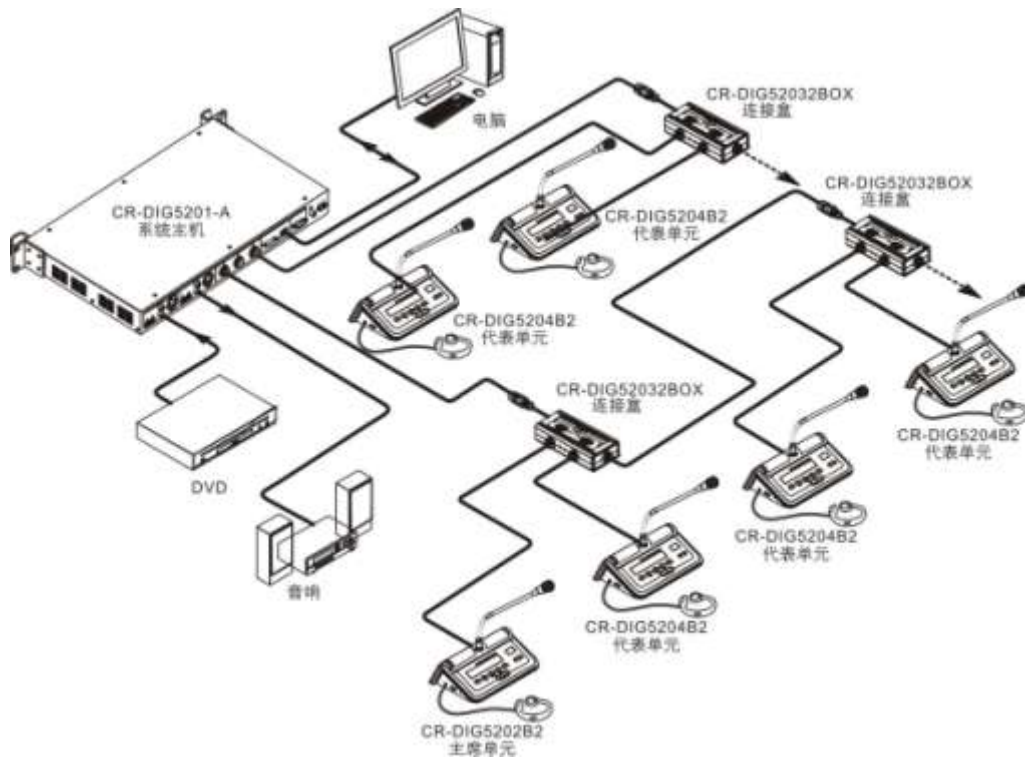

## 4.2 Active expand connection box

Active expand connection box

CR-DIG5200EXP of all digital conference system is a connection box to provide power and enhance signals for conference unit.

### 4.2.1 features

- ◆ with communication status indicator to provide fault tips
- ◆ can be connected to 4-way unit, can provide 350W power at the maximum.

### 4.2.2 Descriptions of panel functions

Vertical view:



Interface view:

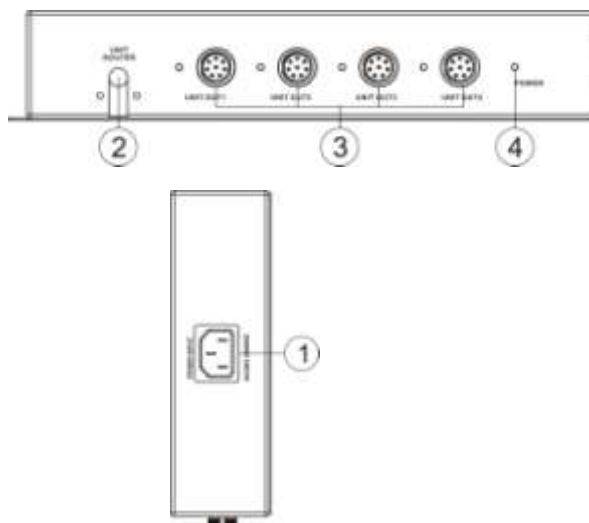

- ① **POWER INPUT—Power input port**  
Connect power input port, supports 110/220V AC power input.
- ② **UNIT ROUTER—aviation bus**  
1.6 m air bus.

- ③ **UNIT1~UNIT4—speak Unit Interface**  
4-way speech unit interface, 8core air outlet, used to connect unit machine.

- ④ **POWER—power indicator**  
Indicator light up when the connection box Normally powered

### 4.2.3 technical parameters

parameters	CR-DIG5200EXP
Power Supply	110/220V AC
Power consumption	350W
Unit interface	
input	1 2M 8 core air line
output	4 8 corer air line
dimensions(mm )	280LX180WX53H
color	Dark gray

## 4.4 connection diagram

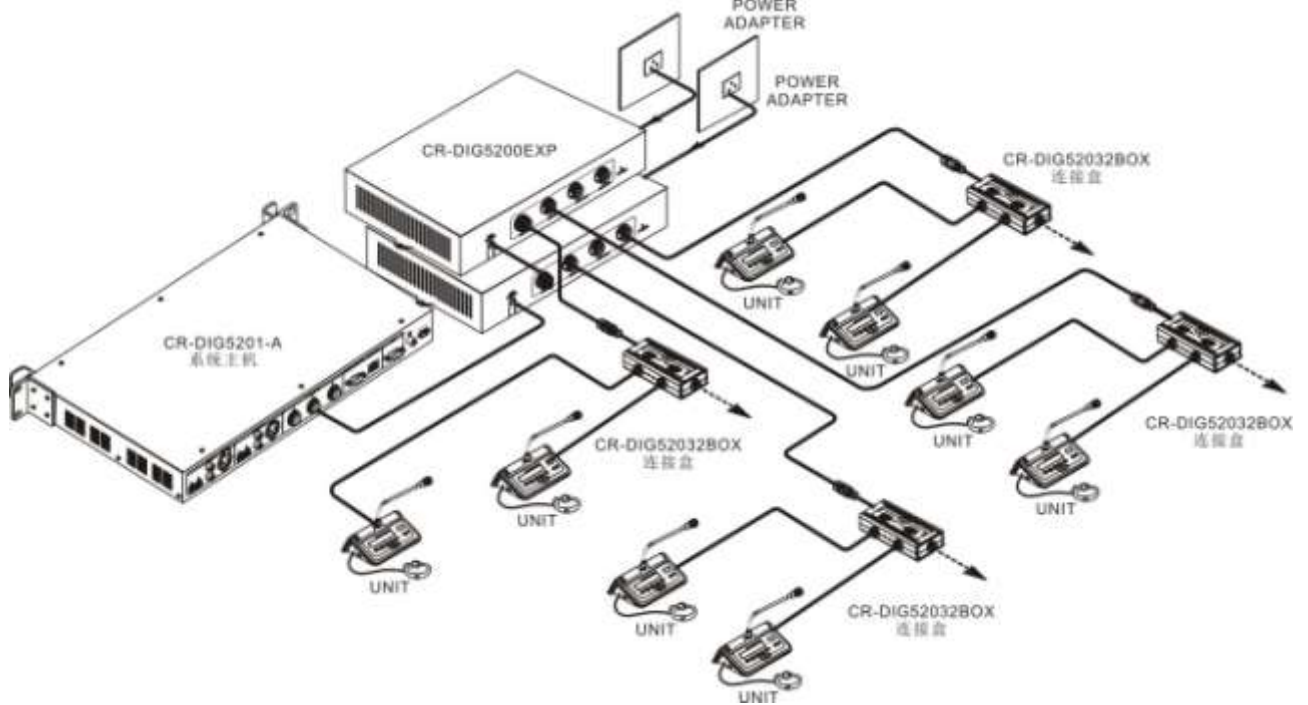

## Chapter5、 examples of speech unit operation

The display operation interface, the interface

function and method of operation of the speech units of full-digital conferencing systems are similar. We will choose the surface microphone units of chairman CR-DIG5202A2 and delegate speech unit CR-DIG5204A2 to illustrate the speech unit display screen clearly.

Properly connect and start the system and conference unit, under the mode of the meeting, the Chairman units will display:



The buttons on the screen of Speech unit are corresponding to the buttons on the front panel of speech unit. During the operation, you can directly press the corresponding button on the panel of speech unit, such as:

'Launch the vote "corresponds to the number" 1 "key

Initiate the sign "corresponding number" 2 "key

"Service" corresponds to the number "5" key



The following instructions will use chairman unit as an example to illustrate that chairman unit has a priority to speak and the function of initiating attendance and voting.

## 5.1 Launch sign in

### 5.1.1 Chairman launch sign in

Long press 'launched sign "key on the Chairman unit panel for 2 seconds, then microphone button lights of all speech units flash red, LCD display will show that you've entered the attendance mode.

Press microphone button or insert IC card unit to sign the attendance. The speech microphone key indicator flashes and then be in

solid red state, means attendance is completed. 320X64 display will prompt the machine has signed in and the total number of signing. If microphone indicator is still flashing, that suggests the sign is not successful. Press microphone button to continue the signing. If IC card has inserted in speech unit before launching the sign, the unit will automatically sign when it is initiated.

Long press number key "5" of Chairman unit for 2 seconds, exit sign model and return to the conference mode.

The chairman unit display will show the following results:



The initiation of sign of PC is similar to the above. It can change the total number of sign.

## 5.2 Launch vote

### 5.2.1 Chairman launch vote

Chairman can only initiate three key voting, the default mode is the last time voting. Don't need to sign, three key vote.

Long press number key 1 of the Chairman unit for 2 seconds to initiate a vote. The corresponding indicator light of system Representative units 2, 3, 4 flashes red while LCD display shows voting status. 2,3,4 key indicators will be in solid red state and stop blinking, means vote is successful, LCD display prompts the successful votes. if the indicators keep flashing, indicating that vote was failed or did not vote. You should to press the key to vote.. Long press "5" key for 2 seconds, stop the vote, view voting results; and then long press "5" key 2 seconds to return to the meeting mode.

President initiates vote, the LCD screen displays the following:



If you choose "yes", the display shows:



If the ballot is proceeding, you can reselect even after voting;



if Chairman determines the voting time is up, as shown below, long press "Stop" button for 2 seconds to end the vote;



View poll results after the voting, the display will show voting results;



Press "Exit" button, then following figure appears, long press "Stop" button for 2 seconds to return to the conference mood.



### 5.2.2 PC launch vote

PC can launch five key electoral rating and 3 key vote.

— meeting vote, numbers 2, 3, 4, respectively stands for in favor of, abstain and opposition.

—The Conference election, figures 1-5 represent the different candidates.

— Meeting assessment, figures 1-5, respectively stand for the level of -, -, 0, +, + +.



Voting end, view the election results::

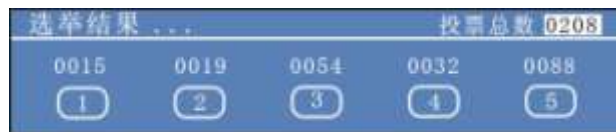

Rating interface:



 Voting procedures and precautions are similar with the "initiating the vote" of Chairman unit, please check a) The Chairman initiate vote.

## 5.3 microphone management

### 5.3.1 Speech mode

1、 the FIFO mode

The largest number of speakers limit is reached, the first open microphone on behalf of unit later statement by the representative unit is switched off.

2、 the NORMAL mode

Reach the limit of maximum number of speakers and other representatives to speak, automatically enters the statement waiting queue, speak to the number of wait queue and set the maximum number of speakers.

### 3、 FREE mode

Allow six representatives to speak, no waiting for.

### 4、 APPLY mode

Representative unit should get the approval from Chairman or operator before speak. Without approval, microphone pole indicator is green.

## 5.3.2 Apply speech

In APPLY mode, Representative units press microphone button to apply to speak t, microphone pole lights are in solid green state. Chairman unit "1" key (corresponding to agree) and "3" key (corresponding to reject) indicators flash and indicate certain representative is applying for speaking. Chairman unit press number "1" key (agree) to approve speech application, then the application is successful. Press number "3" key (reject), Representative application is shut down. The chairman unit approves a Representative unit to speak by pressing the button once, following the "early in early out" principle.

As representative unit apply to speak, Chairman unit LCD displays as below:

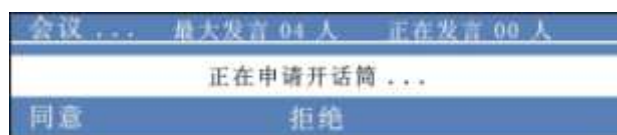

## 5.3.3 Stop speech

long press priority button of Chairman Unit CR-DIG5202B2, the screen will display following diagram interface and close all speaking Representative unit, the number of speaking



## 5.3.4 the biggest statements

The biggest statements of display is set by host menu, to set the maximum allowable number of representatives, not including the Chairman, to speak at the same time.

The system supports 8 microphones simultaneous at the maximum, the maximum number of speakers is 6, only two microphones of chairman unit can be opened at the same time.



## 5.3.5 Speeching

"Speeching" on the display stands for the number of speaking representative units, which does not include the number of speaking chairman units.



## 5.4 Services

In conference mode, press "service" key enter service menu, you can make internal calls, tea applications, language switch, view short messages.



### 5.4.1 language settings

Press "1" key to set language in English or Chinese temporarily.



## 5.4.2 Intercom

Intercom allows secret call between the Chairman, the interpreter, conference units and the operator without affecting the normal meeting. You must use the headset to do internal calls properly, with speakers turned off.

Press "2" key to apply internal call. Unit machine display appears below interface:



If plug in your headphones, select operator, the interface of applying to operator prompts



If operator agrees to the application, internal call is established, you can call, the following interface prompts:



If you do not plug in your headphones, select operator will prompt "Please insert headset call", only when your headphones plugged in can intercom function normally



## 5.4.3 Tea

Tea mainly provides tea service for the

meeting staff. Meeting staff can apply tea service by conference unit.

Press "3" key to enter the "tea" service application interface:



Press "apply" button, the following interface prompts, indicates tea application sent successfully.

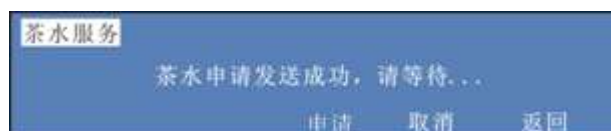

## 5.4.4 Message

View the Message, once message is received, you will hear indicating tone, select "Message" to see the content of short message, as following interface:



Support four short messages at the maximum. Once over four messages, the new message will cover the foremost one according to the sequence

The main differences between Representative unit and Chairman Unit are:

Representative unit can not initiate sign, can not initiate voting, has no microphone priority. Other operations are consistent with Chairman units. Interface as below:



open the microphone interface:



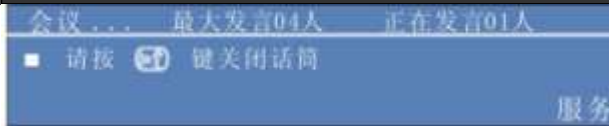

## Chapter 6、Accessories

### 6.1 CR-P2 Earphone (no mic)



#### 6.1.1 Function description

- ◆ can be used in simultaneous interpretation conference unit for monitoring;

- ◆ can be used in conferencing systems to avoid being influenced by others;
- ◆ comes with 1.5 m cable
- ◆ high-fidelity sound quality.

### 6.1.2 technical parameters

technical parameters	CR-P2
Unit interface	3.5mm
Frequency range	80Hz – 20KHz
Sensitivity	90dB
Signal-to-noise ratio (S/N)	> 80dB
Distortion	< 0.1dB
Impedance	32 Ω
Dynamic range	> 85 dB
Output power	100mW

## 6.2 CR-P4CR-P4 earmuffs with microphone headset



### 6.2.1 function description

- ◆ light delicate shape makes users feel more comfortable;
- ◆ work with the translation unit of simultaneous interpretation system for listening and speaking;
- ◆ can be used in conferencing systems to avoid being influenced by others;
- ◆ 40mm high-level special speaker;
- ◆ comes with 2.2 m long cable;
- ◆ high-fidelity sound quality;
- ◆ 32 Ω, 3.5mm

## 6.2.2 technical parameters

technical parameters	CR-P4
Ways to wear	Headset
Frequency range	20Hz – 2KHz
Impedance	32 $\Omega$ $\pm$ 15% $\Omega$
Unit interface	3.5mm
Sensitivity	105dB $\pm$ 3dB
cable length	2.2mm

## 6.3 CR-M4KL415Knob 415mm MIC Stand



### Function description

- ◆ Heart-shaped directional Condenser MIC;
- ◆ High-density 5-core air interface.
- ◆ Normal speech indicator;
- ◆ Speech application indicator.

## 6.4 CR-CT20 conference desktop sockets

- ◆ 1-way front input UNIT;
- ◆ 2-way output: UNIT A and UNIT B connect speech unit
- ◆ Suitable for desktop, wall installation.

## 6.5 CR-CT30 CR-CT30 pop-up conference socket



### **Product Description**

- ◆ 1-way front input UNIT;
- ◆ 2-way output: UNIT A and UNIT B connect speech unit;
- ◆ 1-way universal power connector;
- ◆ Suitable for ground, desktop installation.

## **6.6 CR-CT50 8 core air interface**

### **Product Description**



- ◆ one male and one female, spiral, contractors can weld

## **6.7 Installation of cables**



### **Product Description**

- ◆ the CR-HL 005 5 meters air discuss unit line (8 core)
- ◆ CR-HL 010 10 meters air discuss unit line (8-core)
- ◆ CR-HL 020 20 meters air discuss unit line (8 core)
- ◆ CR-HL 050 50 meters air discuss unit line (8 core)
- ◆ CR-HL 100 100 meters air discuss unit line (8 core)

### **Features**

- ◆ the CR-HL \* used to extend the connection between Conference host and expansion host or Conference speech units;
- ◆ with five optional specifications: 5 m, 10 m, 20 m, 50 m, 100 m

- ◆ 8-core cable, a male and a female connectors;
- ◆ transmission distance up to 1000 m.

CREATOR CORPORATION (CHINA)  
Copyright by CREATOR

Last Revision: 04/2015

